

| | |
|------------|------------|
| Serial No. | H-V001-E-8 |
|------------|------------|

Diaphragm Valve Type 72

User's Manual





Contents



| | |
|--|----|
| (1) Be sure to read the following warranty clauses of our product | 1 |
| (2) General operating instructions | 2 |
| (3) General instructions for transportation, unpacking and storage | 3 |
| (4) Name of parts | 4 |
| (5) Working pressure vs. temperature | 6 |
| (6) Specification of limit switch procedure | 10 |
| (7) Installation procedure | 10 |
| (8) Connection of limit switch procedure | 11 |
| (9) Operating procedure | 12 |
| (10) Adjustment procedure for stopper | 13 |
| (11) Disassembling method for replacing parts | 13 |
| (12) Inspection items | 14 |
| (13) Troubleshooting | 15 |
| (14) Handling of residual and waste materials | 15 |

This user's guide contains information important to the proper installation, maintenance and safe use of an ASAHI AV Product. Please store this manual in an easily accessible location.

<Warning & Caution Signs>

| | |
|--|---|
|  Warning | This symbol reminds the user to take caution due to the potential for serious injury or death. |
|  Caution | This symbol reminds the user to take caution due to the potential for damage to the valve if used in such a manner. |



<Prohibited & Mandatory Action Signs>



| | |
|---|--|
|  | Prohibited: When operating the valve, this symbol indicates an action that should not be taken. |
|  | Mandatory action: When operating the valve, this symbol indicates mandatory actions that must be adhered to. |

(1) Be sure to read the following warranty clauses of our product

- Always observe the specifications of and the precautions and instructions on using our product.
- We always strive to improve product quality and reliability, but cannot guarantee perfection. Therefore, should you intend to use this product with any equipment or machinery that may pose the risk of serious or even fatal injury, or property damage, ensure an appropriate safety design or take other measures with sufficient consideration given to possible problems. We shall assume no responsibility for any inconvenience stemming from any action on your part without our written consent in the form of specifications or other documented approval.
- The related technical documents, operation manuals, and other documentation prescribe precautions on selecting, constructing, installing, operating, maintaining, and servicing our products. For details, consult with our nearest distributor or agent.
- Our product warranty extends for one and a half years after the product is shipped from our factory or one year after the product is installed, whichever comes first. Any product abnormality that occurs during the warranty period or which is reported to us will be investigated immediately to identify its cause. Should our product be deemed defective, we shall assume the responsibility to repair or replace it free of charge.
- Any repair or replacement needed after the warranty period ends shall be charged to the customer.
- The warranty does not cover the following cases:
 - (1) Using our product under any condition not covered by our defined scope of warranty.
 - (2) Failure to observe our defined precautions or instructions regarding the construction, installation, handling, maintenance, or servicing of our product.
 - (3) Any inconvenience caused by any product other than ours.
 - (4) Remodeling or otherwise modifying our product by anyone other than us.
 - (5) Using any part of our product for anything other than the intended use of the product.
 - (6) Any abnormality that occurs due to a natural disaster, accident, or other incident not stemming from something inside our product.

(2) General operating instructions

  - Using a positive-pressure gas with our plastic piping may pose a dangerous condition due to the repellent force particular to compressible fluids even when the gas is under similar pressures used for liquids. Therefore, be sure to take the necessary safety precautions such as covering the piping with protective material. For inquiries, please contact us. For conducting a leak test on newly installed piping, be sure to check for leaks under water pressure. If absolutely necessary to use a gas in testing, please consult your nearest service station beforehand.

  - Do not step on or apply excessive weight on valve. (It can be damaged.)

Caution - Do not use the valve in conditions where the fluid may have crystallized. (The valve will not operate properly.)

 - Keep the valve away from excessive heat or fire. (It can be damaged, or destroyed.)

- Always operate the valve within the pressure vs. temperature range. (The valve can be damaged or deformed by operating beyond the allowable range.)
- Allow sufficient space for maintenance and inspection.
- Select a valve material that is compatible with the media. For chemical resistance information, refer to “CHEMICAL RESISTANCE ON ASAHI AV VALVE”. (Some chemicals may damage incompatible valve materials.)
- Keep the valve out of direct sunlight, water and dust. Use cover to shield the valve. (The valve will not operate properly.)
- Perform periodic maintenance. (Leakage may develop due to temperature changes or periods of prolonged storage, rest, or operation.)
- The travel stop may have to be adjusted if media leakage is detected between the upstream & downstream sides of the valve.
- Bonnet bolt torque should be checked before installation, as they may become loose after long-term storage. A periodic check of the valve condition as well as bonnet & flange bolt torque should be made part of preventative maintenance program properly re-tightening the bolts as necessary. It is especially important to re-tighten all bolts during the first shutdown.

(3) General instructions for transportation, unpacking and storage



 - When suspending and supporting a valve, take care and do not stand under a suspended valve.



 - This valve is not designed to handle impacts of any kind. Avoid throwing or dropping the valve.

- Avoid scratching the valve with any sharp object.

- Do not over-stack cardboard shipping boxes. Excessively stacked packages may collapse.

- Avoid contact with any coal tar creosote, insecticides, vermicides or paint.

(These chemicals may cause damage to the valve.)

- When transporting a valve, do not carry it by the handle.



- Store products in their corrugated cardboard boxes. Avoid exposing products to direct sunlight, and store them indoors (at room temperature). Also avoid storing products in areas with excessive temperatures. (Corrugated cardboard packages become weaker as they become wet with water or other liquid. Take care in storage and handling.)

- After unpacking the products, check that they are defect-free and meet the specifications.

(4) Name of parts

Nominal Size: 200, 250mm (8", 10")

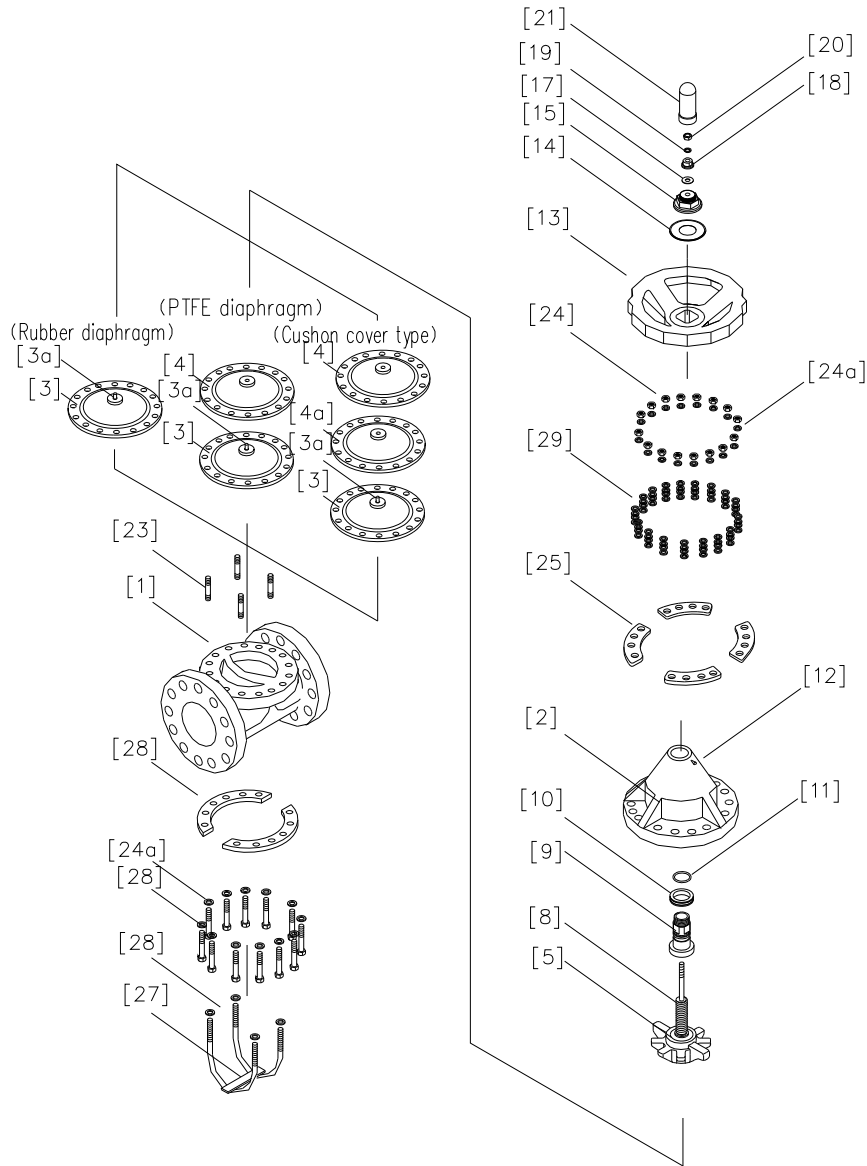

| Nominal size 200, 250mm | | | | | |
|-------------------------|--------------------------------|------|---------------|-------|-----------------------|
| No. | DESCRIPTION | No. | DESCRIPTION | No. | DESCRIPTION |
| [1] | Body | [11] | O-ring(A) | [23] | Stud bolt-nut |
| [2] | Bonnet | [12] | Grease nipple | [24] | Bolt-nut |
| [3] | Diaphragm | [13] | Handle | [24a] | Washer |
| [3a] | Inserted metal of diaphragm(A) | [14] | Name plate | [25] | Bonnet upper liner |
| [4] | Cushion | [15] | Cap | [26] | Body liner |
| [4a] | Cushion cover | [17] | Valve sheet | [27] | Rib liner |
| [5] | Compressor | [18] | Stopper | [28] | U-bolt-nut |
| [8] | Stem | [19] | Spring washer | [29] | Conical spring washer |
| [9] | Sleeve(A) | [20] | Set nut | | |
| [10] | Thrust bearing(A) | [21] | Gauge cover | | |

Nominal Size: 200, 250mm (8", 10") with Limit Switch (Option)

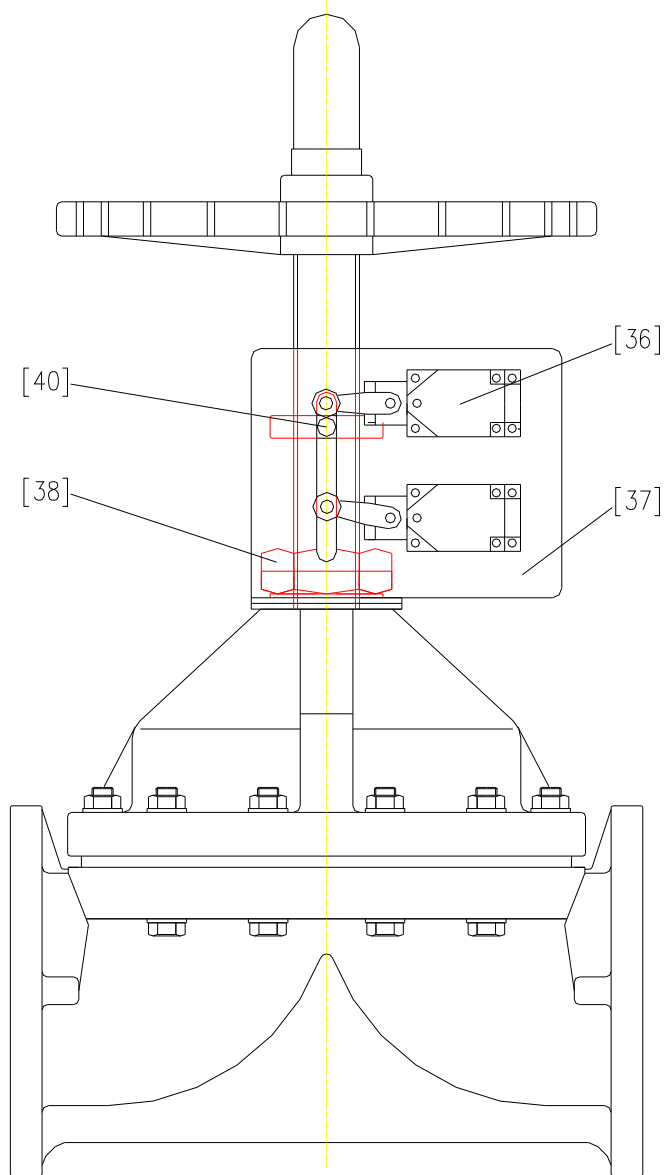

(In case of body material PVC)

| No. | DESCRIPTION | No. | DESCRIPTION |
|------|--------------|------|------------------|
| [36] | Limit Switch | [38] | Nut (A) |
| [37] | Bracket (A) | [40] | Limit Switch Rod |

(5) Working pressure vs. temperature

(1) AV Diaphragm Type 72 Specification of the connection (A specification)

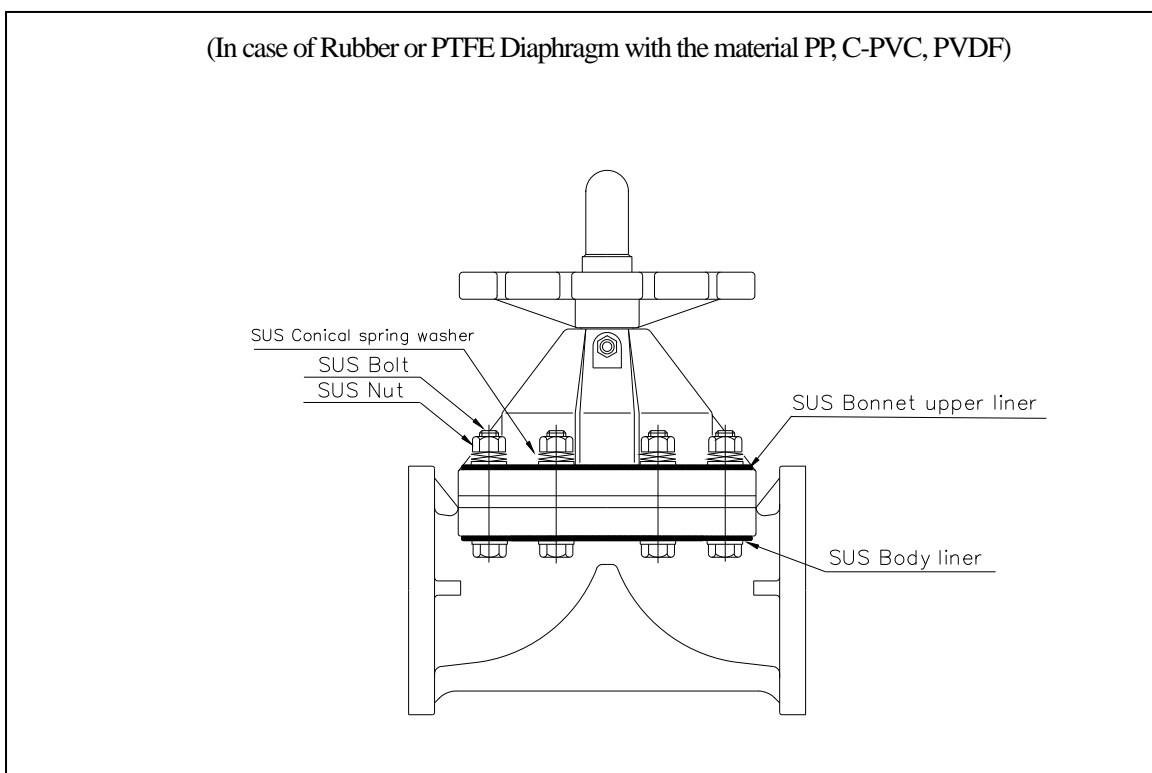
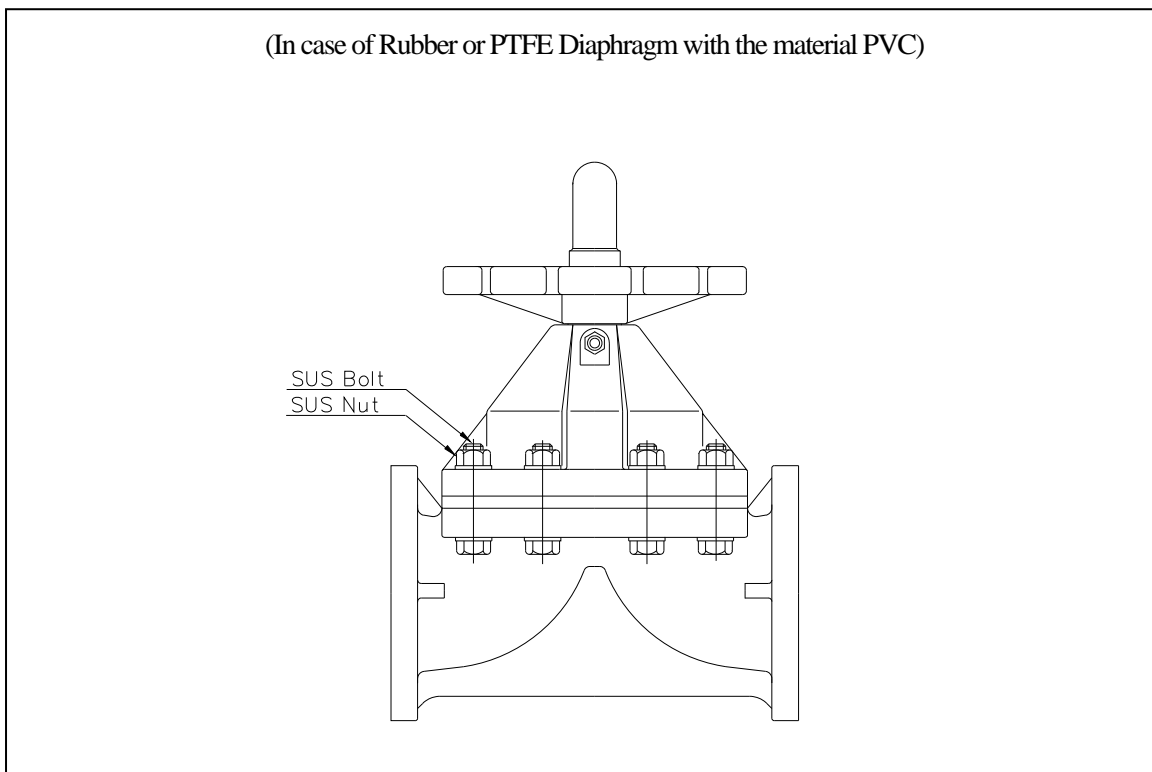

*SUS Conical spring washer is only used with PVDF.

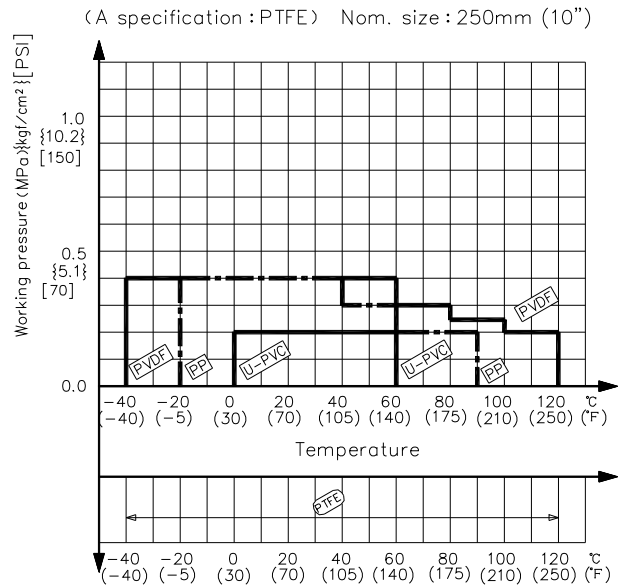
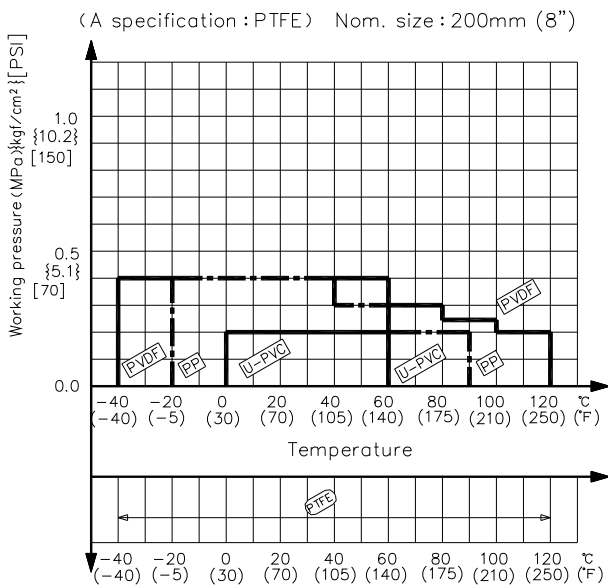
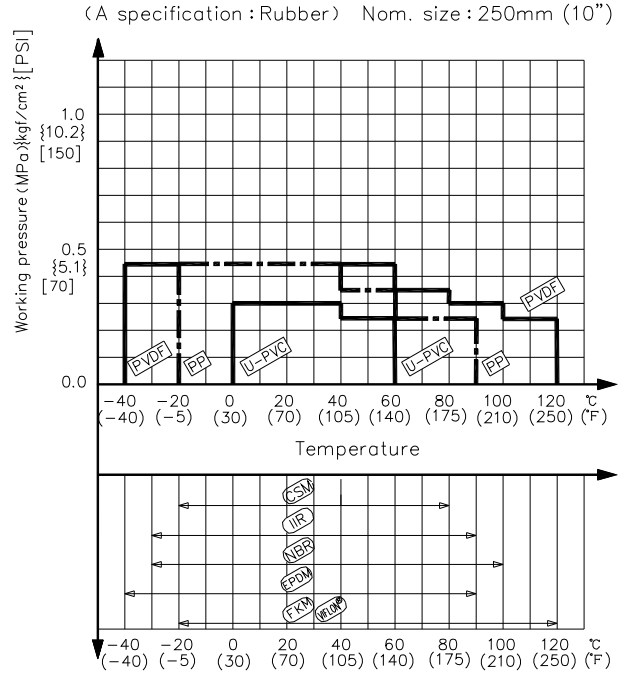
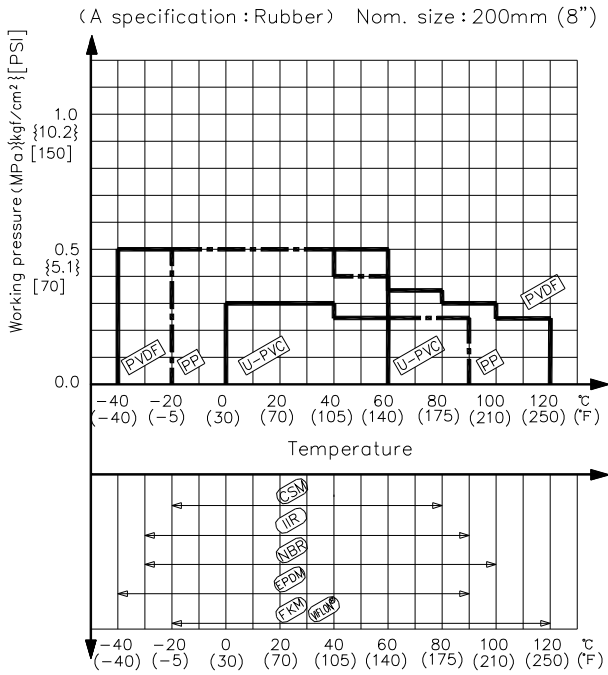

(1) AV Diaphragm Type 72 Specification of the connection (B specification)

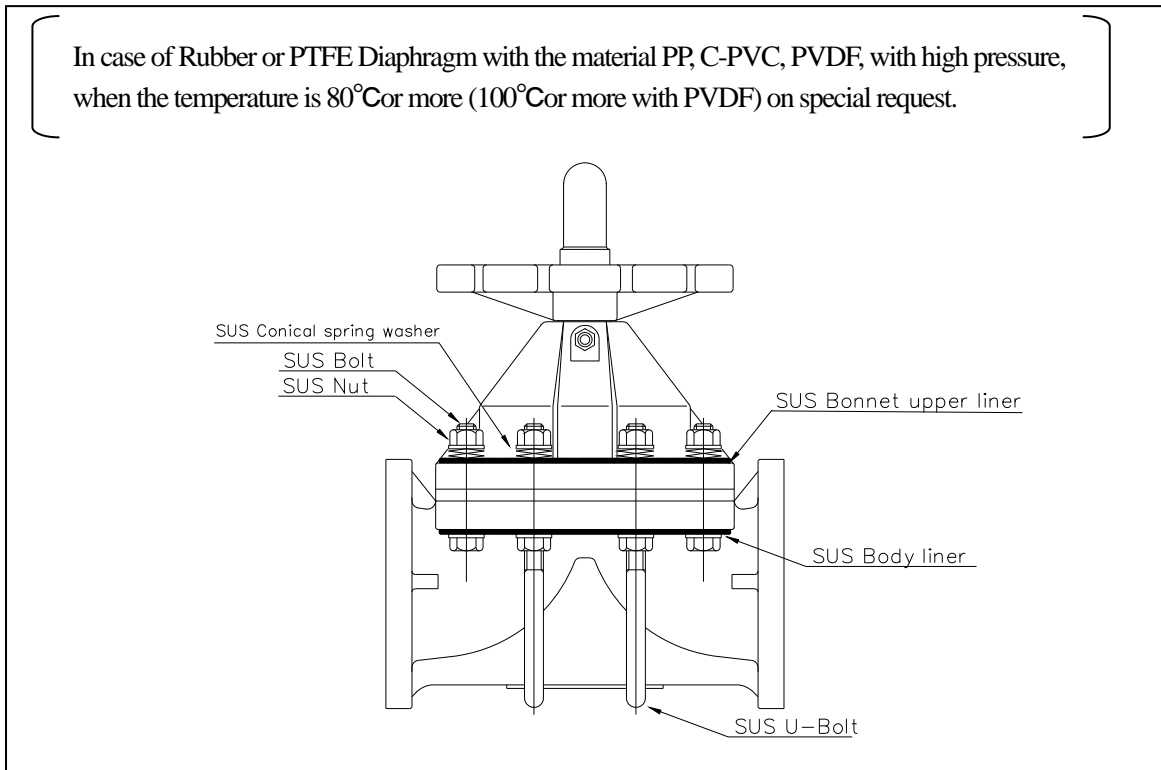
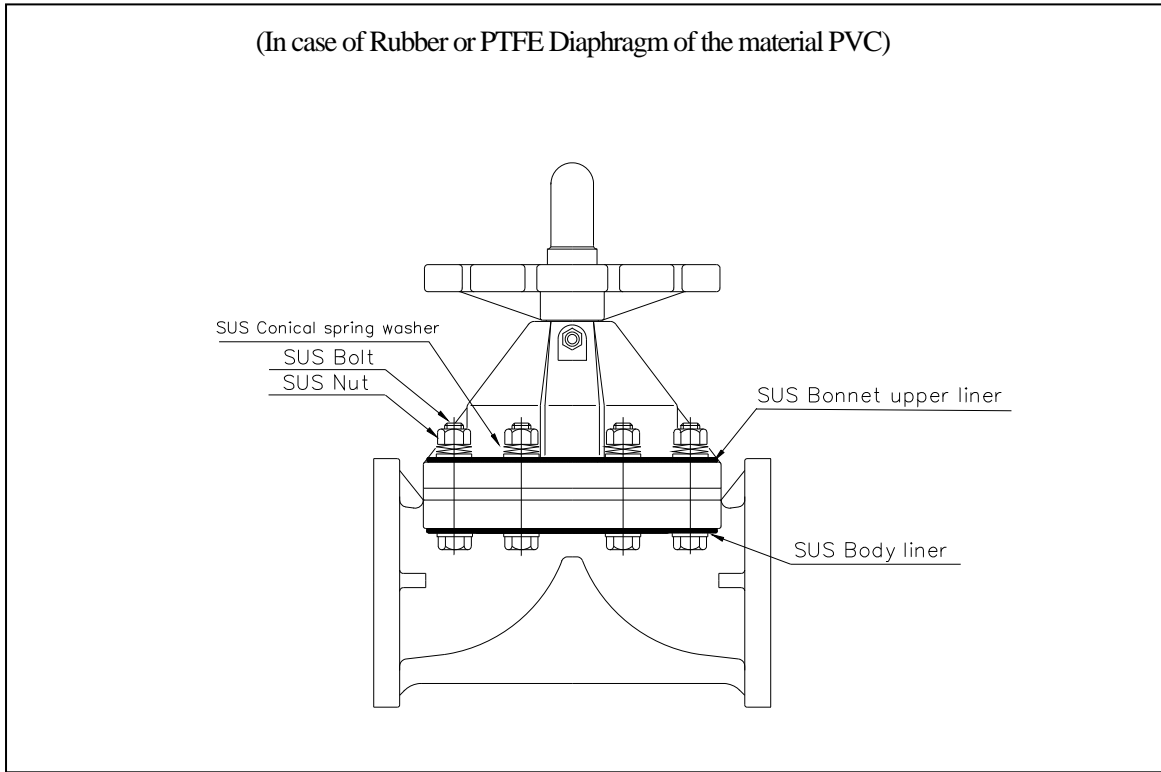

*SUS Conical spring washer is only used with PVDF.

(B specification : Rubber) Nom. size : 200mm (8")

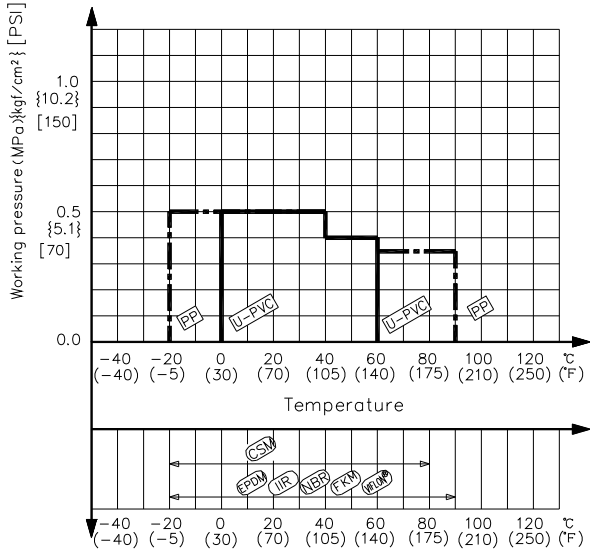

(B specification : Rubber) Nom. size : 250mm (10")

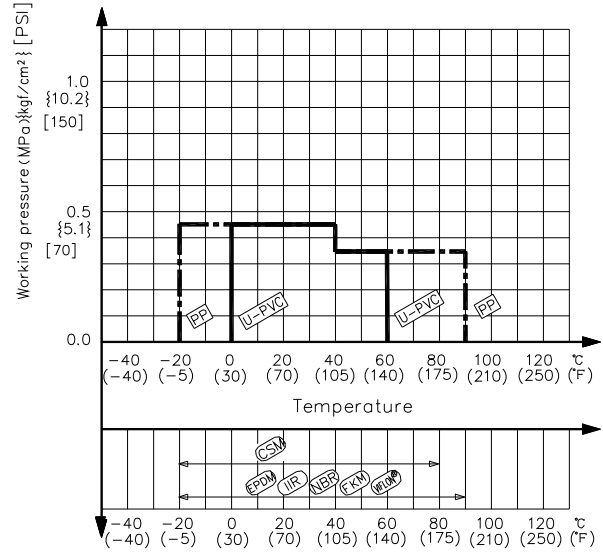

(B specification : PTFE) Nom. size : 200,250mm (8", 10")

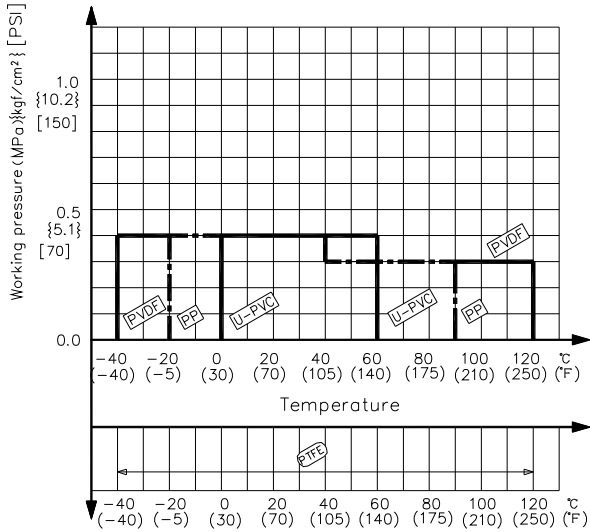

(6) Specification of limit switch (option)

| Nominal Size | Type Code | Protection Grade |
|-------------------------|-----------|------------------|
| 200, 250mm (8", 10") | 1LS1-J | IP67 |

Limit Switch Rating

| Rate Voltage (V) | Resistive Load (A) | Inductive Load (A) |
|------------------|--------------------|--------------------|
| AC125 | 10 | 6 |
| AC250 | 10 | 6 |
| DC115 | 0.8 | 0.2 |
| DC230 | 0.4 | 0.1 |

Connection Diagram

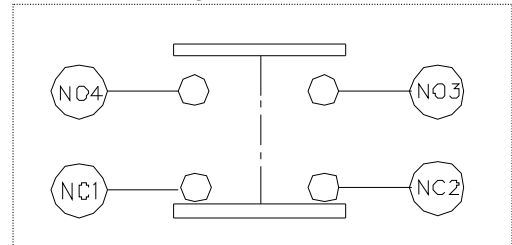

(7) Installation procedure

- Warning** (Warning icon) - When suspending and supporting a valve, take care and do not stand under a suspended valve.
- !** (Warning icon) - Be sure to conduct a safety check on all hand and power tools to be used before beginning work.
 - Wear protective gloves and safety goggles as fluid remain in the valve even if the pipeline is empty.
 (You may be injured.)
- Caution** (Caution icon) - When installing a pipe support by means of a U-band or something similar, take care not to over-tighten.
 (Excessive force may damage the pipe.)
- !** (Caution icon) - When installing pipes and valves, ensure that they are not subjected to tension, compression, bending, impact, or other excessive stress.
- When connecting an ASAHI AV Valve to metal piping, take care not to let the pipe stress on the ASAHI AV Valve.
 - Use flat faced flanges for connection to ASAHI AV Valves.
 - Ensure that the mating flanges are of the same standards.
 - Be sure to use sealing gaskets (AV Gasket), bolts, nuts, and washers and tighten them to specified torques.
 (When a non-AV gasket is used, a different tightening torque specification should be followed.)

- Necessary items
- Torque wrench
 - Spanner wrench
 - Bolt, Nut, Washer (For many flanges specification)
 - AV gasket

Procedure

- 1) Set the AV gasket between the flanges.
- 2) Insert washers and bolts from the pipe side, insert washers and nuts from the valve side, then temporarily tighten them by hand.



- The parallelism and axial misalignment of the flange surface should be under the values shown in the following table to prevent damage the valve.

(A failure to observe them can cause destruction due to stress application to the pipe)

Unit: mm (inch)

| Nom. Size | Axial Misalignment | Parallelism (a-b) |
|-------------------------|--------------------|-------------------|
| 200, 250mm (8", 10") | 1.5 (0.06") | 1.0 (0.04") |

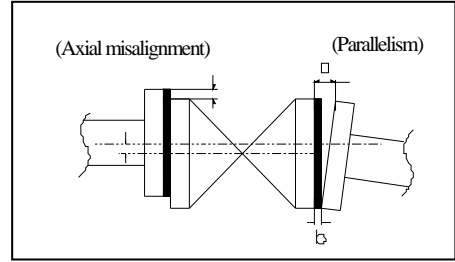

- 3) Using a torque wrench, tighten the bolts and nuts gradually to the specified torque in a diagonal manner.
(Refer to fig.1.)



- Tighten the bolts and nuts gradually with a torque wrench to the specified torque level in a diagonal manner.

Fig. 1

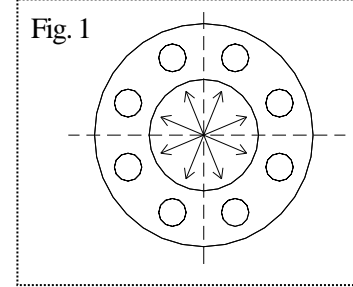

Recommended torque value Unit:N-m{kgf-cm} [lb-inch]

| | |
|---------------|-------------------------|
| Nominal. Size | 200, 250mm (8", 10") |
| Torque value | 55 {561} [488] |

(8) Connection of limit switch procedure (option)



Warning

- Shut down the power on the equipment before connecting wires. There are risks of electrical shock depending on the level of operating voltage.



Caution

- Be sure that the terminal cover and body cover are put on during the operation.
- If you use the limit switch at 1mA-100mA or 5-30V, consult near Asahi dealer.

Necessary items

- Screw driver (+)
- Connector (G1/2)
- Crimp-style terminal
- Wire stripper
- Terminal crimping tool

Procedure

- 1) Loosen the three screws used to attach the limit switch cover with a screwdriver (+) and remove the cover from the limit switch.
*These screws are captive.
- 2) Pull and remove the protective cap, made of resin, from the cover.
- 3) Draw the cable through the connector.
- 4) Strip the cable with a wire stripper.
- 5) Install a crimp-style terminal on the lead wire with a terminal crimping tool.
- 6) Connect the terminal screw with a screwdriver (+) according to the internal circuit diagram show in page 10.
* Tighten the screws. (If not, electric leaks or shocks may occur.)
- 7) Tighten the above three screws with a screw driver (+) to install the cover on the limit switch.
- 8) Tighten the cable by connector.

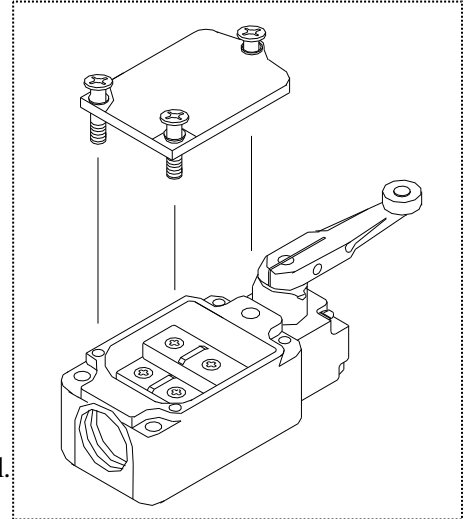

(9) Operating procedure



Caution

- Do not exert excessive force in closing the valve.
- Do not use the valve to fluid containing slurry. (The valve will not operate properly.)
- The installed valve must never be opened or closed when foreign matter such as sand is present in the pipeline.
-  - When operating the handle, be sure to do so with your hand. (Using a tool may damage the handle.)
- If a stopper is loose, adjust it. (To learn how to adjust it, see the operation manual.)

○ Turn the handle gently to open or close.



(Turn the handle clockwise to close - the handle indicates 'S', and counter clockwise to open - the handle indicates 'O'.)

Fully shut The bottom of stopper clings to the top of cap.

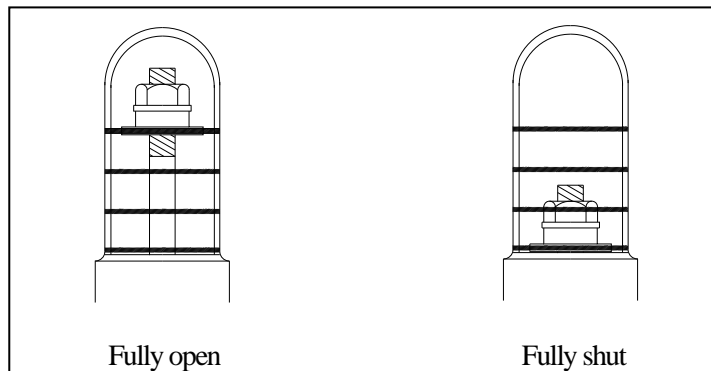
Fully opened The blue line on the top of gauge cover accords with the red line of stopper.



(10) Adjustment procedure for stopper

Caution   - If a stopper is loose, adjust it. (To learn how to adjust it, see the operation manual.)
 - Tighten the stoppers securely. (Too weak a torque on a stopper may cause it to loosen.)

Necessary items



- Two spanner wrenches
- Protective gloves
- Safety goggles

Procedure

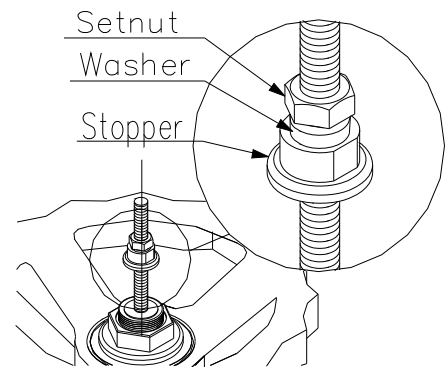
- 1) Remove the gauge cover.
- 2) Fix the stopper and loosen the set nut.
- 3) Loosen the stopper.
- 4) Re-tighten the handle gradually until the fluid stops leaking.
- 5) Fix the stopper so that the bottom of it is touched with the top of seat slightly, and tighten the set nut up to fix.
- 6) Turn the handle back to the original position, and apply grease on the bottom and top of seat.
- 7) Install the gauge cover without allowing the gasket to come off.



(11) Disassembling method for replacing parts

Caution   - Be sure to conduct a safety check on all hand and power tools to be used before beginning work.
 - Wear protective gloves and safety goggles as fluid remain in the valve even if the pipeline is empty. (You may be injured.)
 - Do not change or replace valve parts under line pressure.

Necessary items

- Torque wrench
- Protective gloves
- Spanner wrenches
- Safety goggles

<Disassembly>

Procedure

- 1) Completely discharge fluid from pipes.
- 2) Fully close the valve.
- 3) Remove the bolt nuts of coupled flange and valve body, and remove the valve.
- 4) To disassemble the product, refer to the figure on page 4 to 5, "Name of parts".

<Assembly>

Procedure

Carry out the assembly work in the reverse procedure of its disassembly.

Bonnet torque value

| Nom.Size mm(inch) | Bonnet tightening torque value | |
|----------------------|-----------------------------------|-------|
| | N-m{kgf-cm}[Tb-inch] | |
| | Rubber | PTFE |
| 200(8) | 30.0 | 30.0 |
| | {306} | {306} |
| | [266] | [266] |
| 250(10) | 30.0 | 30.0 |
| | {306} | {306} |
| | [266] | [266] |

(12) Inspection items



Caution - Perform periodic maintenance. (Leakage may develop due to temperature changes or over periods of prolonged storage, rest or operation.)

● Inspect the following items;



| | |
|-----|---|
| (1) | Check for any flaw, crack, or deformation on the outside. |
| (2) | Check whether fluid leaks to the outside. |
| (3) | Check the tightness of coupled bolt nut between the body and the bonnet and that of the gauge cover (loose or not). |
| (4) | Check whether the operation of the handle is smooth. |

※Re-tighten the bonnet diagonally, referring to the bonnet tightening torque value as above.

(13) Troubleshooting

| Problem | Cause | Treatment |
|--|--|--|
| The fluid can not be sealed even when the valve is closed. | Adjustment stopper is working. | Adjuster the stopper. |
| | Foreign matter is in the valve. | Fully open the valve and wash the foreign matter away. |
| | The valve sheet or the diaphragm is scratched. | Repair or replace. |
| The valve can not be opened fully. | Lack of the inserted metal of diaphragm. | Replace the inserted metal. |
| | Compressor pin is broken. | Disassemble and replace. |
| The valve does not operate even when the handle is turned. | Compressor pin is broken. | Disassemble and replace. |
| | Stem is broken. | Disassemble and replace. |
| The fluid leaks from the body and bonnet. | Tightening bolt is loose. | Re-tighten the bolt. |
| | The fluid is crystallized. | Disassemble and clean the valve. |
| | The seal is worn. | Replace. |
| The fluid leaks from the stem. | Diaphragm is broken. | Replace. |

(14) Handling of residual and waste materials



 - Make sure to consult a waste treatment dealer for recommendations on the proper disposal of plastic valves. (Poisonous gas is generated when the valve is burned improperly.)

Diaphragm Valve Type 72

ASAHI YUKIZAI CORPORATION



Distributor

<http://www.asahi-yukizai.co.jp/en/>

Information in this manual is subject to change without notice

2016.4