

User's Manual

Infrared Welding Machine

SP 315-S



Contents

1	Introduction.....	5
2	Safety Messages.....	5
2.1	The User's Manual	5
2.2	Explaining Icons	5
2.3	Safety Messages.....	5
2.4	Welder and Operator Obligations.....	7
2.5	Warranty.....	7
2.6	Transport and Storage.....	7
2.7	Identifying the Machine	7
3	Product Description and Principles of Operation	7
3.1	Intended Use.....	7
3.2	Machine Description.....	8
3.2.1	Component Overview.....	8
3.2.2	Touchscreen / Control Panel	9
3.2.3	Ports and Switches.....	10
3.2.4	Specifications	10
3.3	Welding Process Overview	11
4	Operation.....	12
4.1	Check-out, Turning on, Selecting the Display Language.....	12
4.2	Entering Traceability Data for the Joint.....	13
4.3	Configuring the Machine	14
4.4	Changing Key Data of the Welding.....	15
4.5	Definition of Key Welding Data for Additional Materials	16
4.6	Welding Process	17
4.6.1	Facing the Pipe Butts	17
4.6.2	Checking Pipe Alignment	19
4.6.3	Pre-heating the Pipe Butts and Inserting the Heating Element.....	19
4.6.4	Heat-Soaking Phase	20
4.6.5	Change-over Phase	20
4.6.6	Joining Phase.....	20
4.6.7	Cooling Phase.....	20
4.6.8	End of Welding	20
4.7	Aborted Welding Process.....	21
5	Printing and Transferring Welding Reports.....	22
5.1	The Print Menu and Printing/Transferring Reports.....	22
5.2	Showing Reports in Memory, Reprinting Tags	23
5.3	Deleting Reports from Memory	23
6	System Data.....	23
6.1	Setting the Date and the Time of Day	23
6.2	Enabling Automatic Heating	23
7	Service and Repair.....	24
8	Service and Repair Contact	25



The machine has to be operated exclusively with a power supply line equipped with a protective grounding conductor, as a power supply without this safety element may cause severe machine damage. If the machine is operated through a power supply without a grounding conductor, this will void any and all warranty under which the product may be.

1 Introduction

Dear Customer:

Thank you very much for purchasing our product. We are confident that it will meet your expectations.

The development, manufacture, and check of the infrared welding machine has been guided by our concern to offer a unit characterized by superior operation safety and user-friendliness. The unit was manufactured and checked according to state-of-the-art technology and widely recognized safety regulations.

To ensure maximum operation safety, please conform to the appropriate messages in this booklet and the regulations for the prevention of accidents. Carefully read the User's Manual to avoid damage to the machine or hardware in its environment as well as injury.

This manual is applicable to the following machines:
agru SP 315-S

Thank you.

2 Safety Messages

This User's Manual contains important instructions for operating safely the infrared welding machine agru SP 315-S. Every person who operates the machine will have to conform to the instructions of this manual.

The machine has been developed and checked with respect to welding AGRU materials. For welding other makes, no experiential data are available and/or no liability or warranty can be assumed for the fitness and the reliable operation of the machine.

2.1 The User's Manual

The User's Manual is presented according to sections which explain the different functions of the machine. All rights, in particular the right to copy or reproduce (in print or electronic form) and distribute as well as to translate, are reserved and subject to prior written authorization.

2.2 Explaining Icons

The following expressions and icons are used in this User's Manual to refer to safety-related issues:



Caution

This icon indicates that non-compliance may result in a hazardous situation that possibly causes bodily injury or material damage.



Important

This icon indicates important messages related to the correct use of the machine. Non-compliance may cause problems of operation and damage to the machine.



Info

This icon indicates tips and useful information for using the machine more efficiently and more economically.

2.3 Safety Messages

Protect the power supply cord from cutting edges. Have an authorized service shop replace damaged cables or lines immediately.

The machine has to be operated with a 400 V, 50/60 Hz power supply with safety fuse or breaker of 32 A. If power is connected through a power line manifold, the power supply has to feature an earth-leakage circuit breaker.

The length of the power supply cord is 4 m (13 feet). The length of an extension cable should not exceed 10 m (30 feet).



Caution

Parts Under Power

After opening the machine or removing the cover, parts of it are accessible that may be under power. The device may be opened exclusively by an authorized service shop.



Caution

Pipe Facing Tool

Start the pipe facing tool only when it is in its working position. When facing pipes, do not wear jewellery; if needed, wear a hair snood or net. It is forbidden to remove shaving from the machine while the facing process is running. Make sure nobody is present in this danger zone.



Caution

Heating Plate

When working with the machine, be extremely cautious while the heating plate is operating. Since the heating plate and its guard presents a very high temperature during the welding process, it must not be operated if unobserved, and sufficient distance has to be ensured to combustible materials in its surroundings. Do not touch the heating element or the heating element guard.



Caution

Danger of Bruises and Injury

Do not remain in the danger zone while the machine opens or closes and be sure not to have your hands between the moving and the fixed parts of the machine. The forces exercised by the machine are so high that it will not be able to detect and recognize parts of the body.



Caution

Acceptable Work Conditions

The work zone has to be clean and has to have proper lighting. It is dangerous to operate in a humid environment or close to flammable liquids. In regard of this, acceptable work conditions have to be ensured (e.g., sufficient distance from the machine to other functional areas of the workshop).



Important

Power Supply Only through Line with Protective Grounding Conductor

The machine has to be operated exclusively with a power supply line equipped with a protective grounding conductor, as a power supply without this safety element may cause severe machine damage. **If the machine is operated through a power supply without a grounding conductor, this will void any and all warranty under which the product may be.**



Important

Power Only to Operational Machine

Power must never be applied to the machine before it is completely installed and ready for operation.



Important

No Foreign Bodies in Work Area

The machine must never be used if there are foreign bodies or objects in the work area; in particular, it must not be started if anything obstructs the smooth movement of any movable part or component of the machine.



User's Manual

The User's Manual has to be available at any time on the site where the machine is used. If the User's Manual should come to be incomplete or illegible replace it without delay. Feel free to contact us for assistance.

2.4 Welder and Operator Obligations

- The machine may be operated exclusively by persons who are familiar with the applicable regulations, the guidelines for the prevention of accidents, and the User's Manual.
- The machine may be operated only when observed. Welders must have been introduced properly to operating the machine or must have participated in a dedicated training. The operating/owning company engages to check at reasonable intervals if the machine is operated by the welders with the intended use and under proper guidelines of safe work.
- The machine must never be operated if not in proper state of repair. Before welding, the welder is required to make sure that the state of the machine is in order.



Important

During transport, the support console of the heating element and facing tool has to be secured with the transport locks at all times. When installing the machine, remove the transport locks before applying power to the machine.

2.5 Warranty

Warranty claims may be raised only if the conditions for warranty given in the General Terms and Conditions of Sale and Shipment obtain. Furthermore, the provisions and instructions contained in the User's Manual have to have been respected.

2.6 Transport and Storage

During transport, the machine must be at all times in the transport box it is shipped in. Ensure that the console with heating element and facing tool is locked during transport.

The transport box should also be used to store the machine. The machine has to be stored in a dry location, be clean or has to be cleaned, and be locked against unwanted operation.

2.7 Identifying the Machine

Each machine is identified by a name plate. It shows the machine model ("Typ"), the serial number ("Nr."), and the manufacturer.

Infrarot-Stumpfschweißmaschine	
Typ	agru SP 315-S
Nr.	31506011
Netz	230V IP54 50/60Hz 1700W
Hersteller	agru Kunststofftechnik Ing.-Pesendorfer-Str. 31 A - 4540 Bad Hall Tel. +43 7258 7900
CE	

3 Product Description and Principles of Operation

3.1 Intended Use

The agru SP 315-S Welding Machine is designed exclusively for welding plastic pipes and fittings using the infrared welding technique (butt welding without contact).

Only the welding parameters shown on the touchscreen display (preprogrammed by the manufacturer or defined by the user) can be selected for a welding operation. Any modification of the welding parameters contained in the control software is strictly prohibited.

It is also part of the intended use to conform to the instructions provided in the User's Manual.



The manufacturer can in no circumstances be held liable for damage or consequential damage that occurs as a result of the non-compliance with the procedures described in the User's Manual, the modification of the manufacturer-programmed welding parameters, or non-intended use. Any such deviation or modification will cancel any and all warranties under which the product may be.

3.2 Machine Description

The machine can be used as an in-shop installation and with anodized aluminum components, it is also suited for clean room applications. The machine enables users to enter the data that are relevant for the welding process and for the traceability of the welded joint. From the entered welding parameters, it calculates the applicable forces and temperatures and controls the welding process automatically.

All welding and traceability data are entered either directly on a touchscreen panel or read from a bar code using a scanning pen. The welding process is monitored in its entirety and saved to a welding report. All welding reports can be printed or transferred to a computer with a suitable pipeline network management software (such as DataWork agru).

Using the menus displayed on the touchscreen, the machine can be customized to the application at hand (see section 4.3, Configuring the Machine).

3.2.1 Component Overview

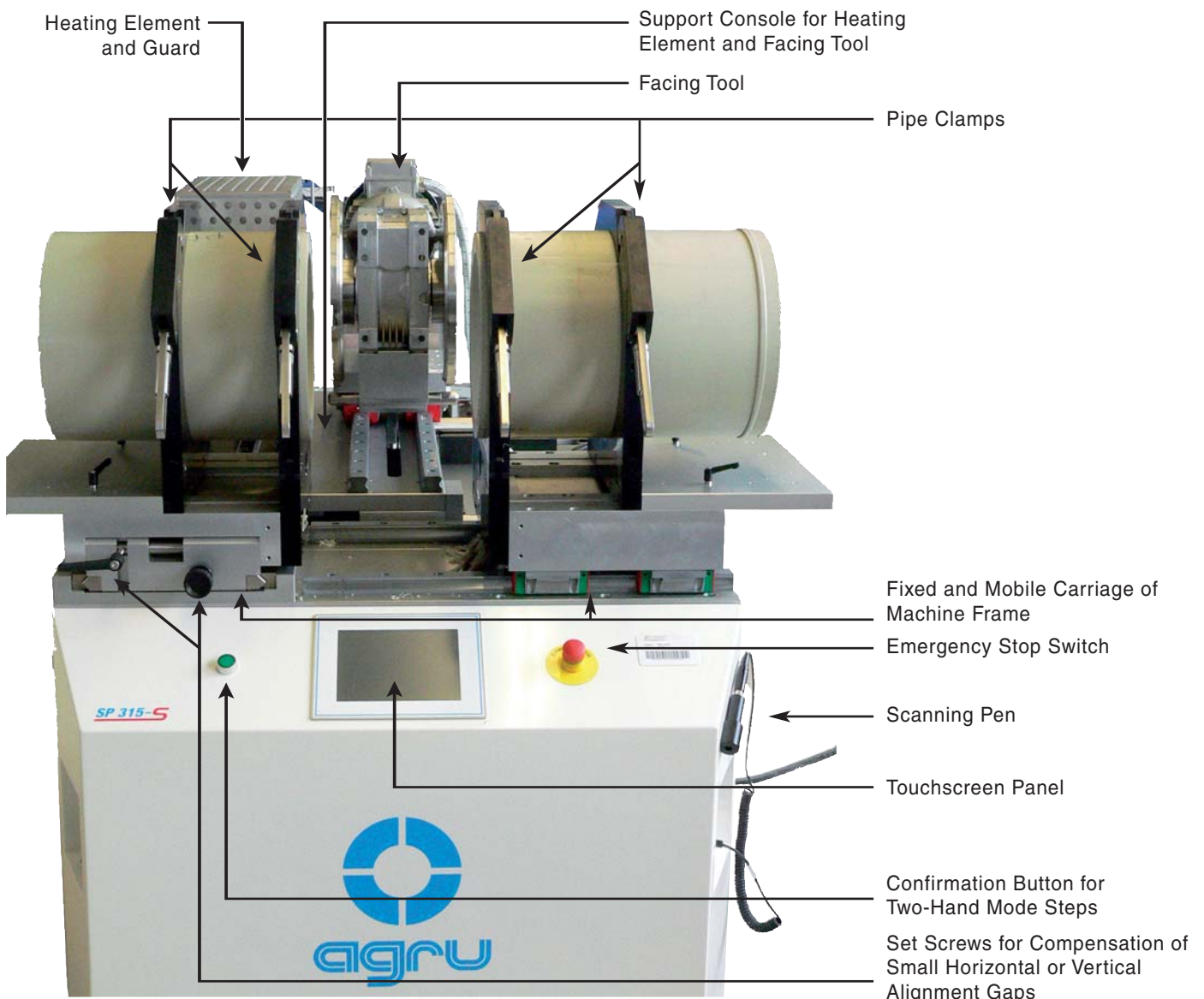



Ball Guide Bushing of Support Console (4 in total)

Runner Blocks of Support Console (6 in total)

Power Supply Cord to Facing Tool

Rail for Transport Lock and Transverse Guiding of Support Console

Power Supply Cord from Mains

Runner Blocks of Movable Carriage (4 in total)

Door of Equipment and Storage Cabinet (Reducers, Accessories)

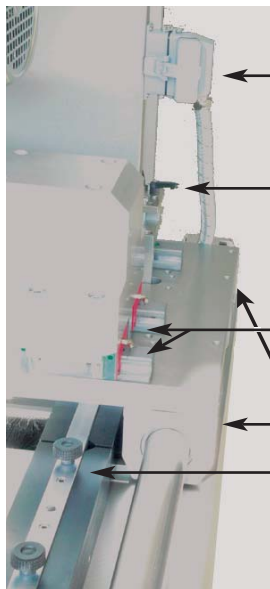

Power Supply Cord to Heating Element

Transport Lock Blocking Heating Element Movement

Runner Blocks of Support Console (6 in total)

Ball Guide Bushings of Support Console (4 in total)

Installed Transport Lock Blocking Transverse Console and Longitudinal Facing Tool Movement

3.2.2 Touchscreen / Control Panel

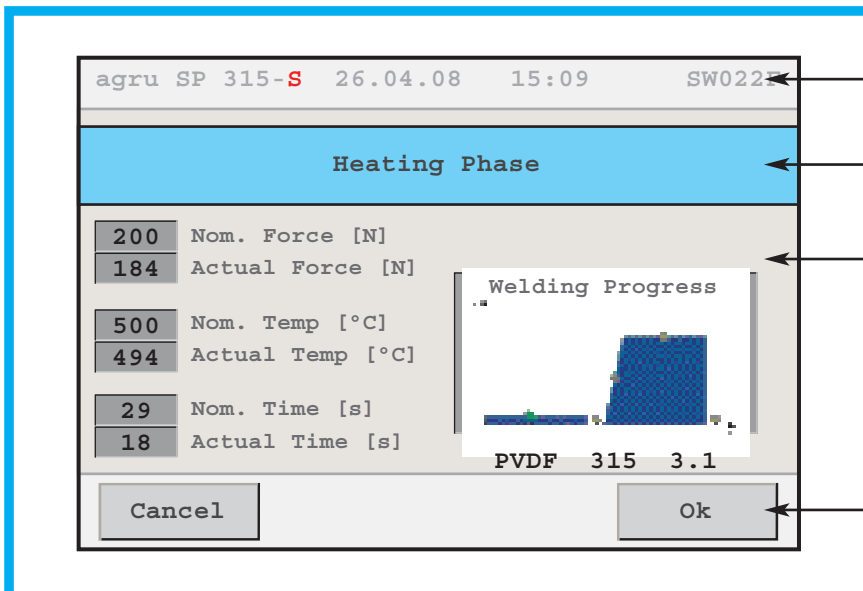

Status Bar

Title Band

Multifunctional Area (changes depending on context of display)
 - Display of/data on welding progress
 - Parameter menus to configure operation settings
 - Input keyboards
 - Error messages/Notes

Navigation Bar with User Interface Buttons

3.2.3 Ports and Switches

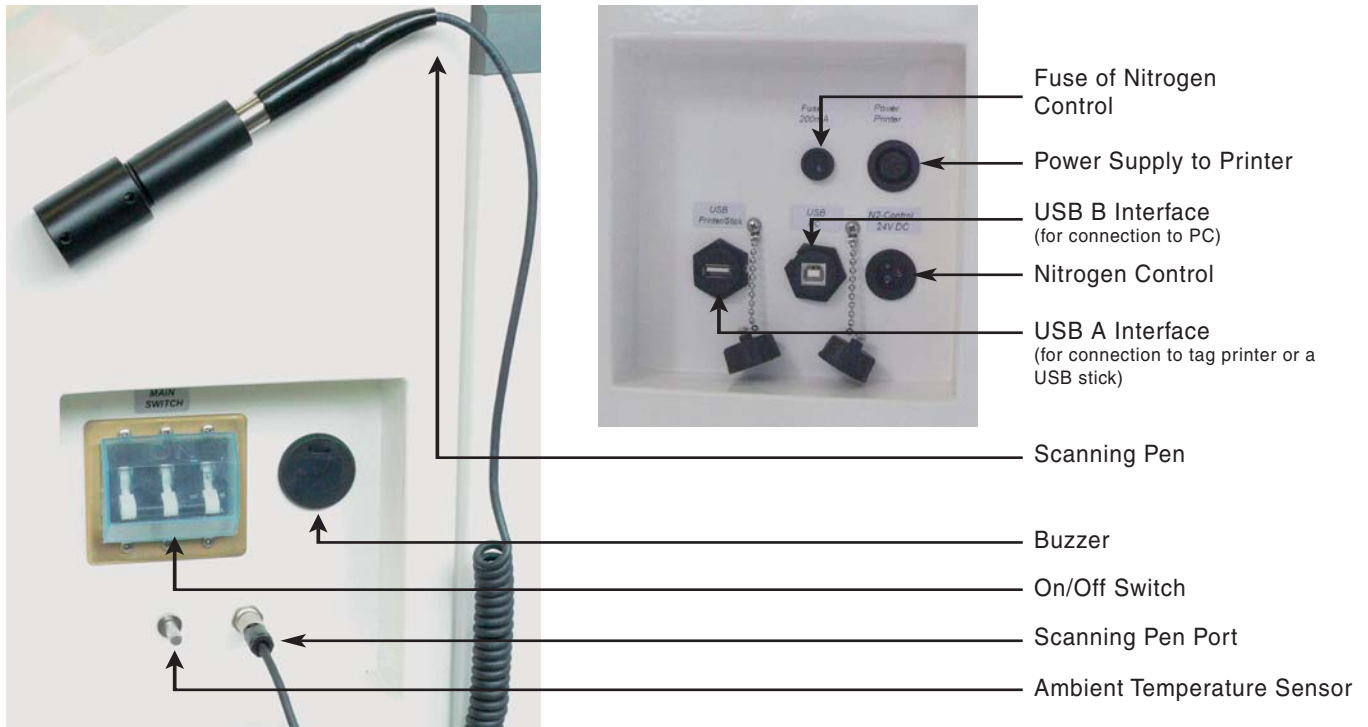

3.2.4 Specifications

agru SP 315-S	
Power Supply Characteristics	
Voltage	400 V AC \pm 10%
Frequency	50/60 Hz
Total Rated Power	13 kW
Heating Element Power	9 kW
Facing Tool Power	1.1 kW
Welding Operation Specs	
Welding Force	3500 N
Speed of Facing Tool	23 rpm
Ambient Temperature (operation)	+0°C to +40°C (32°F to 104°F)
Ambient Temperature (storage)	-5°C to +50°C (23°F to 122°F)
Operating Range	110 - 315 mm (4-3/4" - 12-1/2")
Dimensions and Weight	
Dimensions (W x D x H)	
Machine in transport box, w/o support legs	1400 x 1700 x 1070 mm (4' 4" x 5' 7" x 3' 6")
Machine only, excluding printer bracket and support legs	1045 x 1580 x 1310 mm (3' 5" x 5' 2" x 4' 3-1/2")
Weight	approx. 1100 kg
Maximum Carriage Stroke	268 mm (10-1/2")

 **Important** The power supply connection is designed as a 3-phase plus earth ground connection. No neutral conductor is needed. The power supply connection should be rated at 32 amps and should be wired with an automatic safety switch of 32 amps medium-slow blow. The conductor section of the power supply connection should be minimum 4 sq. mm.

 **Important** For the connection to mains power an approved CEE plus and outlet have to be used and wired according to the specifications quoted above. Compare also the photograph as well as its legend and explanations below.



1. CEE Power Outlet 32 A
2. CEE Power Plug 32 A with integrated phase inverter
3. Contact Socket for Phase 3 (L3)
4. Contact Socket for Neutral (not needed with SP 315-S)
5. Contact Socket for Earth Ground (PE); a little thicker than the other sockets
6. Contact Socket for Phase 1 (L1)
7. Contact Socket for Phase 2 (L2)
8. Contact Pin for Phase 3 (L3)
9. Contact Pin for Neutral (not needed with SP 315-S)
10. Contact Pin for Earth Ground (PE); a little thicker than the other pins
11. Contact Pin for Phase 1 (L1)
12. Contact Pin for Phase 2 (L2)

Prior to starting to first use the machine, the power supply connection has to be verified. Across any two phases (L1-L2, L2-L3, L1-L3) a voltage of 400 V AC \pm 10 % has to be found. If a neutral is wired to the same power supply socket, across any of the three phases and the neutral, a voltage of 230 V AC has to be found. These measurement can be take with any common voltmeter for alternating current voltages.

If connected appliances are equipped with a motor requiring 3-phase alternating current supply, as is the case with the SP 315-S, the rotating field of the machine has to have the proper direction. The SP 315-S checks this and if the rotation is incorrect, a "Power Supply Error" message is displayed. To change the direction of the rotation of the field, the phase inverter in the plug can be used. Two of its contact pins are placed on a grey turning disk. A flathead scredriver can be used to turn this disk, thereby inverting the positions of the two pins, which in turn inverts the rotation of the field.

3.3 Welding Process Overview

The welding process is performed as follows:

- Pipes are clamped into the frame; depending on the form of the component to be welded, this may mean that the outer clamps have to be re-adjusted or that reducer inserts have to be inserted.
- Pipe butts are worked by the facing tool, which is inserted automatically, to obtain abutment along a fully parallel plane.
- Pipe alignment is checked and confirmed on the touchscreen.
- Automatic insertion of the heating element; when inserting it, the heating element has to be clean.
- After the heating element was inserted, the pipes close in automatically at the predefined force.
- When the carriages close in, they also align the heating element exactly in-between the pipe butts.
- At the same time, the pipe butts are heated to the predefined temperature.
- When the heat-soaking phase is over, the pipes are moved apart and the heating element is removed automatically.
- Once the heating element is removed, the pipes close in again automatically.
- This is followed by a steady force increase until the fusion force is reached.
- The pipe then cools down at the predefined force.
- After the cooling time is over, the force is automatically removed from the carriages and the pipe or fitting can be taken out of it.

4 Operation



Important

Prior to the first use of the machine, the transport locks that avoid longitudinal and transverse movement of the console supporting the facing tool and the heating element have to be removed (see photographs on page 9). An Allen wrench for removing the transverse lock is included with the machine.

The control software of the machine monitors the transport lock status. When the machine is turned on with the locks in place, welding cannot be started and an error message shows (see photograph on this page).



Important

Whenever the machine is moved, the transport locks have first to be installed. Damage due to the fact that the machine was moved without installed transport locks is not eligible for warranty. The transport lock may be installed and removed only when the machine is turned off. Damage due to non-compliance with this provision will also disqualify from warranty.

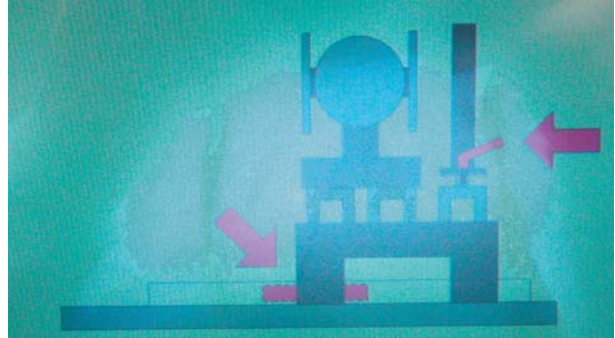

4.1 Check-out, Turning on, Selecting the Display Language

Place the machine on a level surface and ensure it cannot slide. Sufficient distance has to be kept to other areas in the workshop, especially to those in which combustible materials are used, in order for the heating element temperature of up to 500°C (930°F) not to be hazardous.

Depending on the piece that is going to be welded, the outer clamps may have to be repositioned or removed. To do so, loosen the locking bolts and either remove the clamp or re-adjust it and secure it by tightening the locking bolts again.

If the diameter of the pieces to be welded is smaller than the clamp, insert the reducer inserts. This can be done with the enclosed Allen key.



Important

Pipe clamps and reducer inserts have to be clean or must be cleaned before welding starts. To insert or remove the inserts, do not use heavy tools (hammer, wrench). They may damage the inserts.



Important

The surfaces of the heating plate have to be free of grease and clean, or they have to be cleaned.



Important

Make sure all connectors are tight in their sockets and make sure that the machine is operated only if the conditions for safe and intended use are met (see also section 2).

After preparing the machine for welding and connecting the power supply cord to the mains power supply, the machine is turned on using the On/Off switch. The welcome screen, as reproduced in Display 1, appears on the touchscreen panel. Touch the appropriate button to select the display language that the machine will use.

After the language was selected, the machine takes the user to the welder code entry

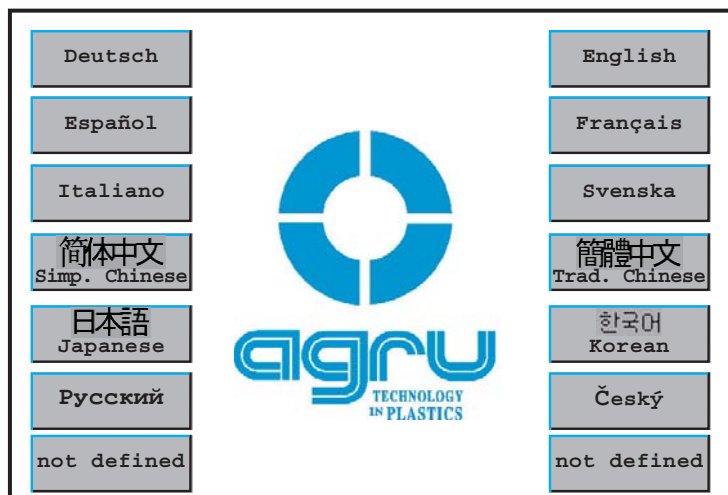

Display 1

screen. Without a valid welder identification code, it is impossible to start welding processes on the machine, since the machine is unblocked for operation only after a valid welder identification code was entered.

Enter the welder identification code by typing it on the touchscreen and saving it to memory by touching the “Ok” button. If a bar code for the welder code is available, you can also read it from the bar code using the scanning pen.



All inputs for which a bar code is available can be entered from the bar code using a scanning pen.

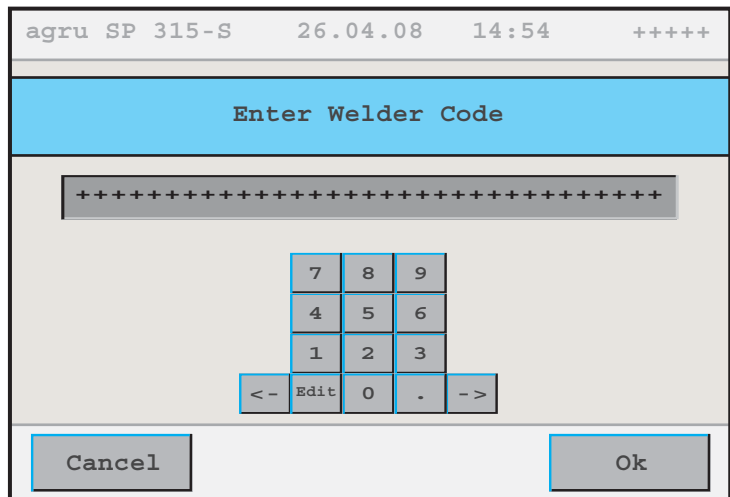

Display 2



Important

Entering data on the touchscreen must always be performed with the bare finger. Using objects (ballpoint pens, screwdrivers, etc.) may cause unrecoverable damage to the surface of the touchscreen.

4.2 Entering Traceability Data for the Joint

After the welder identification code was entered, the traceability data for the joint have to be entered. The machine displays the traceability data for the last joint that was welded (see Display 3), which can be re-used for the next welding operation by simply touching the “Ok” button.

If traceability data are not the same as for the last joint, change the data that are different by touching the appropriate “Change” button. Depending on the kind of data you want to change, the machine displays either a numeric keypad (see Display 2) or an alphanumeric keyboard (see Display 4). To confirm and save your data input to memory, touch the “Ok” button.



Depending on the software version installed in your machine, some screens may differ slightly on your machine from the reproductions in this manual.

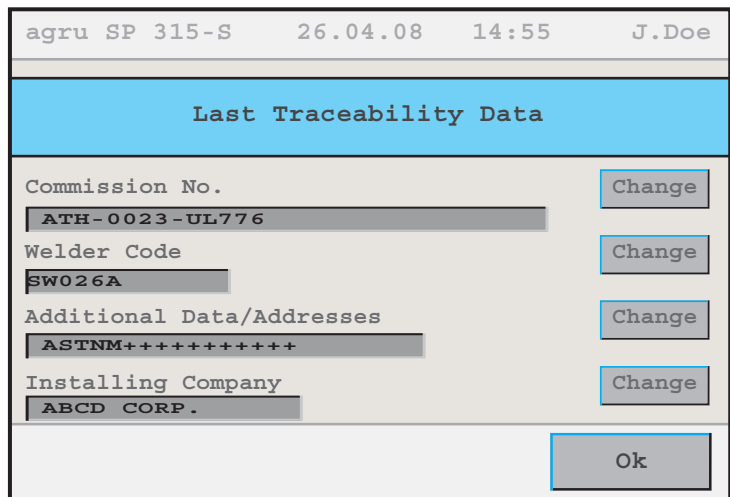

Display 3

When the traceability data were entered, the machine displays the first input screen of the welding process proper (see Display 5). In this display, it is possible to start the welding process and to customize the configuration of the machine.

When going on from traceability data input to the welding process proper or the input of characteristic welding data, the machine perform a calibration of the points of reference for its movable parts. Make sure this short process is not interrupted.

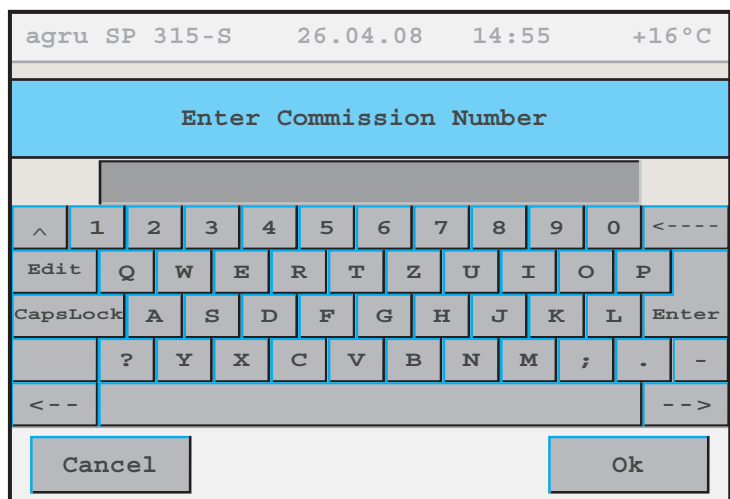

Display 4

The welder will enter all settings and perform all control actions on the touchscreen panel.

4.3 Configuring the Machine

In the first input screen of the welding process proper (Display 5), the key data of the last welding are shown (material, diameter, and wall thickness of the welded pipe). Furthermore, the status bar at the top of the screen shows the date, time of day, and also either the current ambient temperature or the power supply voltage or the welder's name or code.

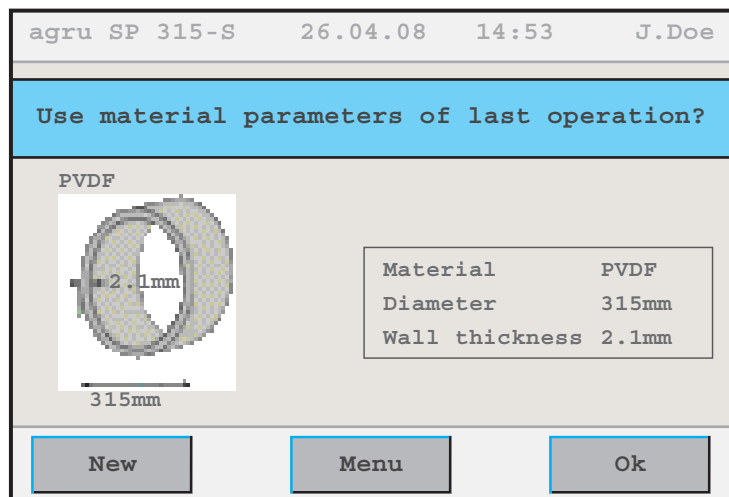

Display 5

In Display 5, the welder has the possibility to:

- immediately start a welding process that will be performed with the same welding parameters as the previous welding (touch the “Ok” button and move on to section 4.6);
- enter new pipe-related data for the next welding (touch the “New” button and move on to section 4.4);
- change the machine settings in the configuration menu (touch the “Menu” button);
- to read a new welder ID code using the scanning wand; or
- display the date for the next scheduled maintenance on the screen by touching “New” button for some time.



When the confirmation pushbutton on the front is touched simultaneously, the three buttons in Display 5 have the following functions:

New Locking the machine, so it will only be able to use it again by entering a valid welder identification code.

Menu Closing in the movable carriage of the machine toward the center (“closing” the machine).

Ok Moving the movable carriage apart toward the edge (“opening” the machine).

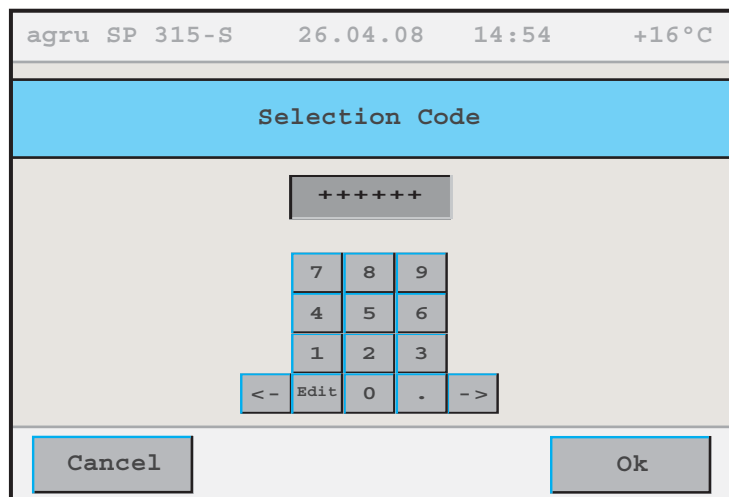

Display 6

The first five options of the configuration menu are immediately accessible, the other options will be displayed only after an access code for the machine, the so-called selection code, was entered (see Display 6). The menu has the items listed in the following table. To toggle between various possible settings, or to open a sub-menu for a given menu item, touch the appropriate button.



Some of the buttons next to menu option change their color when they were pressed and are then displayed as though the button is held down. In this case the “held down” button mean that this menu option is the selected option.

Designation	Setting	Description / Data to be entered
Number of Tags	Menu	In a sub-menu, the number of tags to be printed for sticking them onto the welded pipes, can be selected.
Show Reports	Menu	In a sub-menu, it is possible to select a job number in order to display the welding reports of this commission. In report display mode, it is also possible to print a label tag for this welding once again (see section 5.2).

Unit of Length (mm / inch)	Menu	In a sub-menu, the unit of length used for displaying and saving welding data can be selected.
Temperature Unit (°C / °F)	Menu	In a sub-menu, the temperature unit used for displaying and saving welding data can be selected.
— New Page in Menu —		
Automatic Heating	Menu	In a sub-menu, a time, for instance on the following morning, can be pre-set when the heating element will start heating up automatically (see sub-section 6.2).
Alarm Sound	On / Off	By touching this button, the alarm sound that the machine emits to validate the execution of a given step in the process can be enabled or disabled. Whatever this setting, the sound will be heard to indicate the imminence of the change-over phase.
Select Language	Menu	In a sub-menu, the language in which display texts and reports are edited can be selected.
— New Page in Menu —		
Memory Control	ON / OFF	if ON: Machine stops when the memory is full; if OFF: Machine overwrites the oldest report when the memory is full.
Machine Parameters	Menu	In a sub-menu, the machine number can be entered and the temperature of the heating mirror and the welding force can be zeroed/calibrated. <i>Access to this sub-menu requires an additional access code that is available from the manufacturer/distributor.</i>
Date/Time	Menu	In a sub-menu, date and time can be set.
Delete Reports	Menu	In a sub-menu, it is possible to delete all welding reports currently in memory. <i>To access this sub-menu, the so-called selection code is required (see at the beginning of this sub-section); the reports will be deleted only after another safety warning was confirmed.</i>
— New Page in Menu —		
Additional Materials	Menu	In a sub-menu, the key data for welding can be defined for pipe materials that are not available yet.

4.4 Changing Key Data of the Welding

In the welding-individual start screen (see Display 5), it is possible to change the weld-specific key data for the joint to be welded. To do so, touch the “New” button. The screen that allows selecting the material of the pipes that are going to be welded, is then displayed on the touch-screen panel (see Display 7). To select a material, touch the appropriate button on the screen.

Default Materials are those pipe materials that are defined by default when the machine is shipped. Additional Materials, if any, are those pipe materials that were defined by the user in the definition screens accessible from the appropriate configuration menu option (see section 4.5). The maximum number of additional materials is three.

When the appropriate button was touched to select a pipe material, the screen changes and displays the selection of pipe diameters, with default and additional diameters just as for the materials. Finally, a third, similar screen allows selecting the appropriate wall thickness.

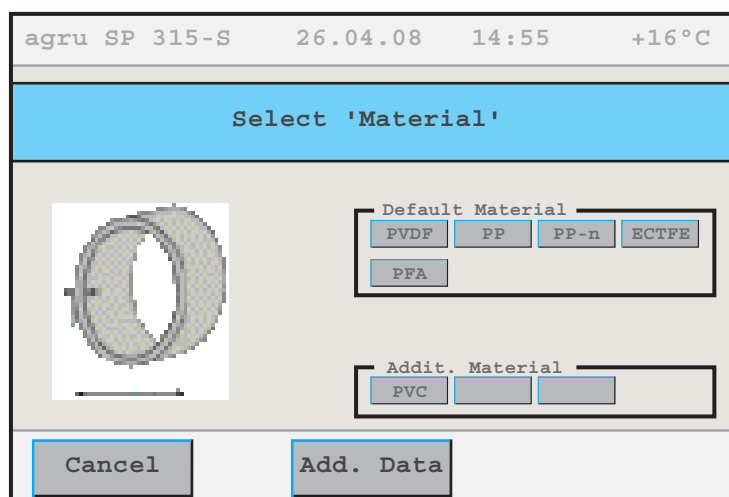

Display 7

Note that a screen will not appear if it would not make sense to display it. For instance, if only one wall thickness is defined for a given pipe diameter, the wall thickness selection screen will not show. Moreover, when you select an additional material, this has to be confirmed by entering the so-called selection code (see sub-section 4.3). Default materials can be welded without entering this code.



Important

The machine must never be used to weld pipe materials, diameters, and thicknesses other than those available in the key welding data screens. The manufacturer is in no circumstances liable for damage or consequential damage that occurs as a result of deviations from these pipe data or of modifications or attempted modifications to the control software. Furthermore, this will cancel any claims to warranty expressed for the machine. To make a material available in this screen, it has to be entered previously with all its technical welding parameters in the configuration menu.



Info

Welding PFA pipes is subject to a valid license for this pipe material. Therefore, when this material is selected (either from the default materials or from the additional materials, if defined), a message to this effect is displayed. The license key is disclosed either by the manufacturer or the distributor of the machine or when you purchase the PFA pipes and can then be entered in the machine parameters.

In all screens that allow changing the key data for the welding operation, by touching the “Additional Data” button, it is possible to access the additional traceability data and change them as needed.

4.5 Definition of Key Welding Data for Additional Materials

The configuration menu (see section 4.3) has an option “Additional Materials,” which allows defining the key data the machine should use when welding pipes of a material that is not currently available in the machine.

If no additional, operator-defined pipe material has been saved to system memory, the unit displays an input screen that allows entering the name of the material for which the key data for welding it shall be defined. Enter the name on the touchscreen keyboard (see Display 4) and confirm it by touching the “Ok” button. The machine moves on to the next input screen, in which a pipe diameter for this material has to be entered on the numeric keypad (see Display 2). After having confirmed this input by “Ok” once more, another screen allows entering the wall thickness for this material and size. After the wall thickness, the pressure level per SDR has to be entered in the next screen. After this, define the key welding parameters for the material just entered, e.g. 315 mm PVDF pipe with a wall 3.1 mm thick. To define them, the unit guides the operator through a series of input screens in which the following can be entered: joining force, heat-soaking time, cooling time, plate temperature, force ramp, facing force. Confirm every entered value by touching “Ok.”

If key data for welding additional, user-defined materials have already been entered and saved previously, the unit shows a screen that resembles Display 8. Use the arrow keys in the upper area of the screen to switch back and forth between the various additional pipe materials currently in memory. For every pipe material, up to three pipe diameters can be defined, and for each diameter, up to two wall thicknesses or SDR values. By touching one of the “Input” buttons on this screen, the key parameters for welding this material can be edited. Touching the leftmost “Input” button in Display 8 will allow entering, changing, or deleting the welding parameters for 315 mm PVDF pipe with a 3.1 mm wall. Using the second “Input”

button from the left, the welding parameters for 315 mm PDVF pipe with another wall thickness can be entered, and all other “Input” buttons allow entering the parameters for PVDF pipe with other diameters.

As soon as one of the “Input” buttons was touched, Display 9 shows. From this screen, it is possible to edit in various ways the specific data “branch” of which the “Input” button was used to access Display 9. The button “New Parameters” allows entering from scratch all welding parameters for this branch in the data “tree” of which the “Input” button was touched. Data input proceeds as described at the beginning of section 4.5: from the name of the pipe material through to the temperature the facing force.

Touch the “Edit Parameters” button to change the value of a single welding parameter in the appropriate data “branch”. Touching this button will let you access a screen in which the parameter you want to change can be selected from all the key data that need to be defined. From that screen, an input screen is accessed in which the value can be changed; then confirm the change by touching the “Ok” button.

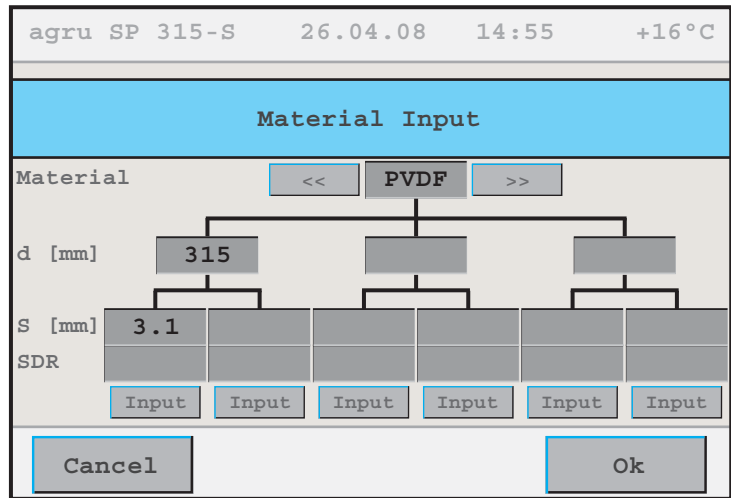

Display 8

The “Delete Parameters” button can be used to delete that “branch” of the data “tree,” of which the “Input” button was used to access Display 9. Deleting has to be confirmed in another safety message, and then the key data for welding the material, from joining force to plate temperature, are deleted along with the appropriate wall thickness or SDR. If this wall thickness or SDR is the only one left for the pipe diameter in question, then the diameter is deleted from the data “tree” too. And if the thus deleted diameter is the only one left for this pipe material, the entire “tree,” including the material itself, is deleted.

By touching the “Delete Parameters Completely” button, it is possible to delete the parameter of **all** additional, user-defined pipe materials. Here too, deleting is possible only after confirming it in a safety message. After deleting them, only the default materials with which the machine is shipped, remain.

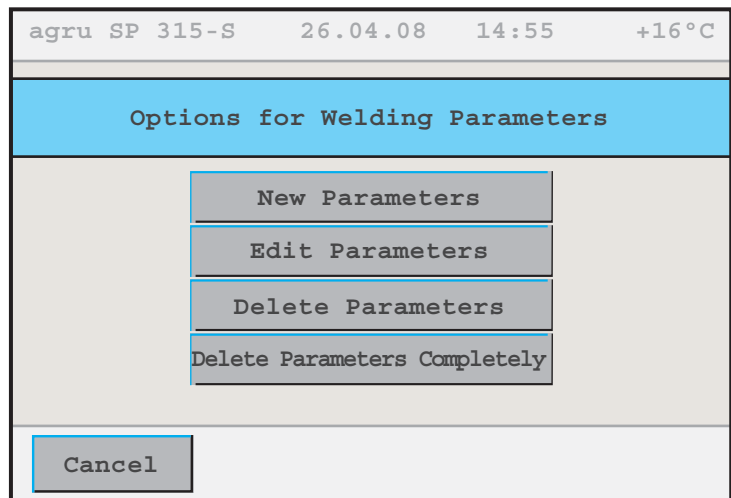

Display 9



If the material that was used in the last welding operation is deleted, then the next welding operation of necessity requires a new material to be selected for welding.

4.6 Welding Process



Important

The welding machine operates in two-hand mode at any time. For any step in the welding process that may put the operator’s hands at risk of injury because the carriage starts moving, the operator must confirm the step on the touch screen and use the second hand to keep pressed the green confirmation push button on the machine front.

4.6.1 Facing the Pipe Butts

In the input screen reproduced in Display 5, when the “Ok” button was

touched, the welding process proper starts by the insertion of the pipe facing tool. The machine alerts the welder to this next step.

Facing requires three steps:

- Zeroing the facing tool position before clamping the pipes
- Securing the pipes in the clamps und determining the facing road
- Facing the butts

First, the machine asks the operator to insert the facing tool in Position 1. This is the position for zeroing the facing tool in relation to the movable carriage. Confirm this screen and simultaneously hold down the green two-hand operation confirmation button on the machine front. This will cause the machine to bring the facing tool to the zeroing position.



Important

While the machine automatically performs a zeroing calibration of the carriage position when it is switched on (including when power is re-applied after it was switched off using the emergency off button), it is critical to zero the facing tool prior to the facing operation proper, failing what it is not possible to ensure a joint of appropriate quality.

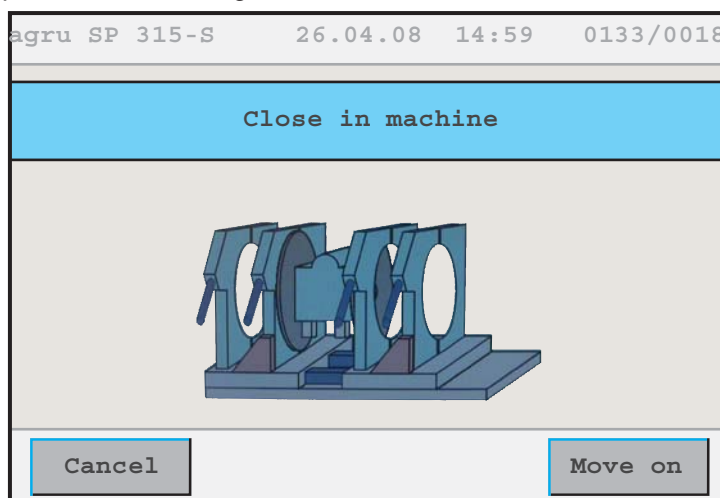

Display 10

When the facing tool handle is located at Position 1, the machine asks the operator to close in the carriage (see Display 10). This is done by touching the “Move on” button and simultaneously holding down the green confirmation push button on the machine front. Then follow the steps the machine indicates on the screen: determine the facing road, clamp in the pipes, and have the machine move the facing tool to Position 2, the facing position. Remember that every action that makes the carriage close in or pull away has to be confirmed in two-hand mode: with the appropriate button on the touchscreen panel and the confirmation push button on the machine front.

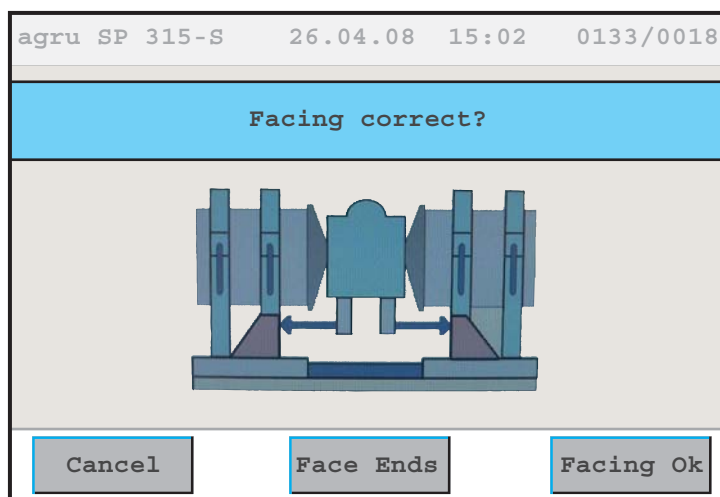

Display 11

Before starting the facing process proper, you can determine the facing road, i.e. the distance that the carriage must travel during facing. To change the value displayed on the screen when the process reaches this step, use the “+” and “-” buttons. The travel length must be a minimum 4 mm. After you changed the facing road, you have to clamp

in the pipes anew. During facing, the machine displays nominal and actual force along with the effective facing road so far achieved.

When the pipe butts are faced, the machine shows an end-of-facing message (see Display 11). Visually check the pipe butts and, if they are o.k., confirm by “Facing Ok”. The machine moves the carriage apart to let you remove the facing tool. If the result of facing is poor, the process can be repeated after touching the “Face Ends” button. To face the butts once again, in most cases the pipes have to be re-adjusted in the clamps.



When pipe facing is successfully finished, it is recommended not to touch the pipe butts with your bare hands. To avoid fatty layers on the pipe, use special pipe handling towels.

4.6.2 Checking Pipe Alignment

When the pipe butts are level to satisfaction, it has to be checked if the pipes align properly to each other or if there is an offset. Similarly as for facing, the touchscreen tells the welder that this is the next step, and the carriage can be closed in on the other pipe by the “Start” button. When the pipe butts are next to each other, two additional buttons appear besides “Cancel”: the “Face Ends” button and the “Alignment Ok” button.

If the pipes align properly, confirm by touching the “Alignment Ok” button, and to start the welding process, the machine will tell you to move the carriage apart and to close the pipe butts at the far end from the heating element with caps; confirm this by “Ok.” Without end caps, the temperature difference between the welded and the open pipe butt may cause a suction effect to form, which would then cool the bead, thereby negatively affecting the quality of the welded joint.

A small offset between the pipes can be readjusted using the adjustment set screws located at the front of the machine. If the alignment offset is too large, or if there is too large or too uneven a distance between the pipe butts, touch the “Face Ends” button to re-adjust the pipes in the clamps and start the facing process again. In both cases, the machine moves the carriages apart to allow for inserting either the heating mirror or the facing tool.

4.6.3 Pre-heating the Pipe Butts and Inserting the Heating Element

When pipe alignment was checked, the machine tells the welder first to reposition the facing tool and heating element assembly to the right. As all actions before, this one has to be confirmed in two-hand mode: touching the appropriate button on the touchscreen and holding down the confirmation push button on the front of the machine. When the facing/heating assembly is in the ready-to-heat position, the machine shows the display asking the welder to insert the heating plate (see Display 12).

Then, the welder can either start the standard welding process that will first launch the heat-soaking phase, or – by pressing the “Pre-Heat” button – can pre-heat the pipe butts before the welding process proper. If he touches the Pre-Heat button, he has to decide in the next screen whether the left-hand side, the right-hand side, or both pipe butts are pre-heated. Touching “Cancel” will return the machine to the previous screen.

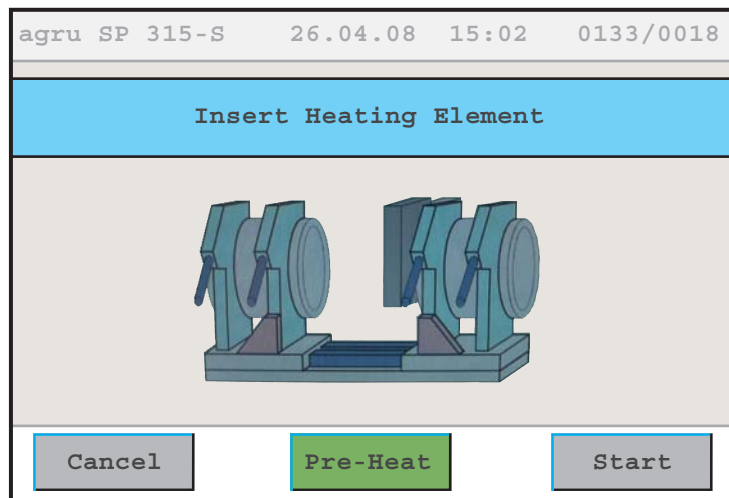

Display 12

i Info If in the control software, the pre-heating time is set to 0 seconds, the machine will skip to the heat-soaking phase of the regular welding in all cases.

👉 Important Using the pre-heating feature is acceptable only for welding fittings of traditional materials or fittings to fittings; pre-heating is designed to be used only when the fitting is securely fastened.

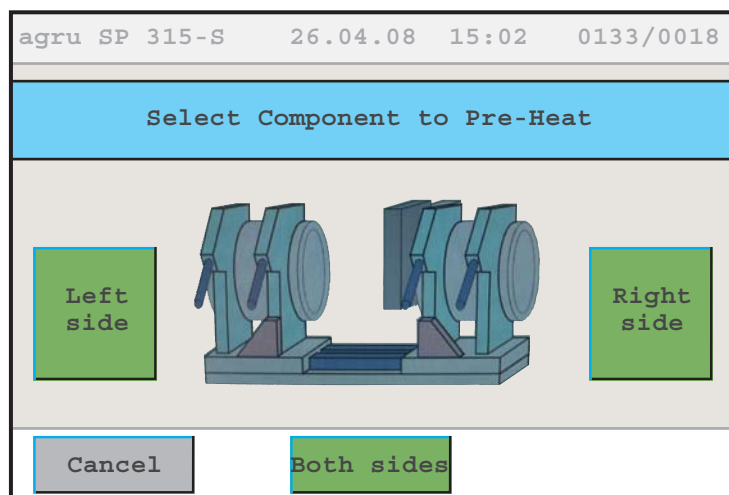

Display 13

While the welding procedure is starting, with or without pre-heating, the machine controls and monitors constantly the temperature of the heating element and the welding force and time. Nominal values and tolerance ranges are defined by the key data for the welding operation previously entered or confirmed. If a value is not within the applicable tolerance thresholds, the machine shows an error message to this effect and the welding process is aborted.

4.6.4 Heat-Soaking Phase

In the first welding phase, the pipes close in on the heating element with the defined welding force and are thereby warmed. During the entire duration of the heating phase, they continue to soak heat from the heating mirror without touching it.

On the touchscreen, the welding progress diagram indicates in which phase the welding currently is (green LED icon). In case of malfunction, the welding process can be aborted by touching the “Cancel” button. If the machine detects a malfunction, the color of the LED icon for the appropriate phase changes from green to red.

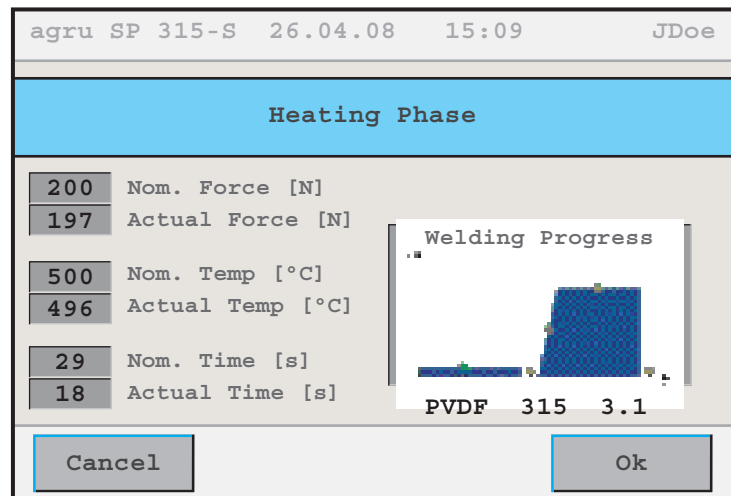

Display 14

4.6.5 Change-over Phase

At the end of the heat-soaking phase the carriages are moved apart automatically. The heating mirror is removed from in-between the pipes, and the carriages close in again; both actions occur automatically. The welding progress diagram on the touchscreen indicates in which phase the welding currently is (see Display 15).

The welder has to monitor the change-over and must abort welding by touching “Cancel”, in case a malfunction occurs.

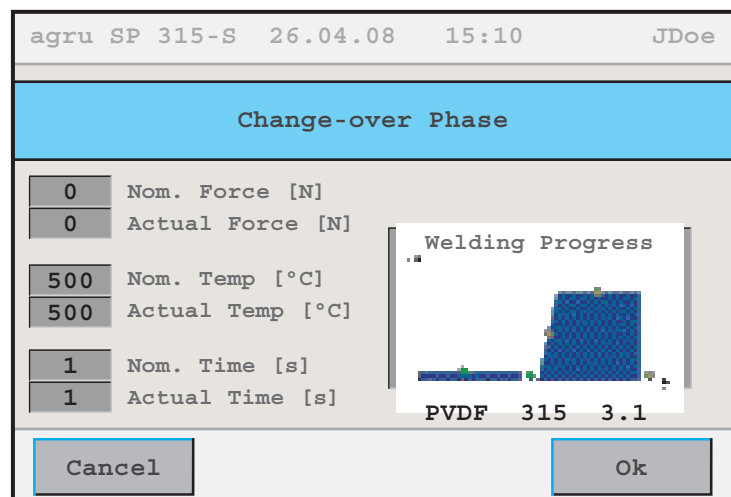

Display 15

4.6.6 Joining Phase

In the joining phase (or, fusion phase) the machine increases the applied force in accordance with the force ramp calculated for the weld. This phase is also indicated on the touchscreen panel.

4.6.7 Cooling Phase

When the full joining force is reached, the machine moves on automatically to the cooling phase (see Display 16). The cooling-down is displayed as a countdown. During cooling, the applied joining force is constantly monitored.

4.6.8 End of Welding

After a successful welding operation, which can also be recognized in the welding diagram, the applied force is removed from the pipes, and they can be taken out of the clamps.

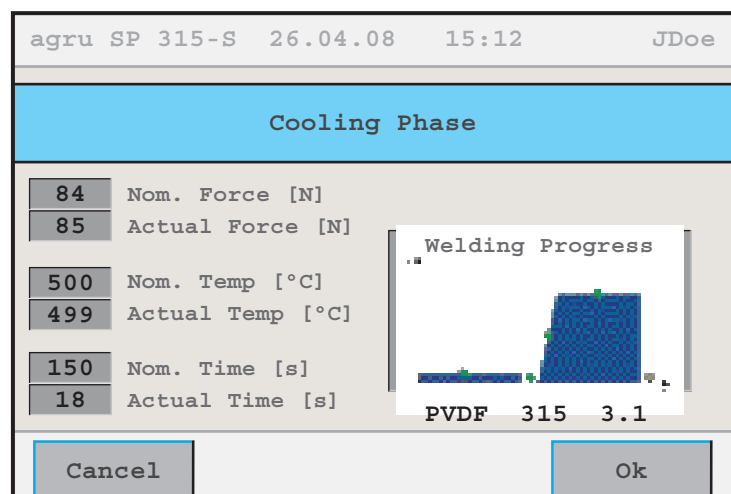

Display 16

When the welding process is finished, the machine displays an overview with the applicable welding and traceability data that will be saved to the report (the screen resembles the one in Display 20), and asks the welder to remove the pipes and visually check the quality of the joint. In case he finds that the joint is of poor quality, although the machine did not alert him to any welding error, he can manually classify the welding result as poor by touching the “Error” button. This causes the machine to mark the joint as poor rather than good in the the welding report.

4.7 Aborted Welding Process

All welding-relevant data are constantly monitored while the welding process is running. If one or more of the parameters are out of tolerance and the machine cannot adjust them, the welding process is aborted after a given period of time.

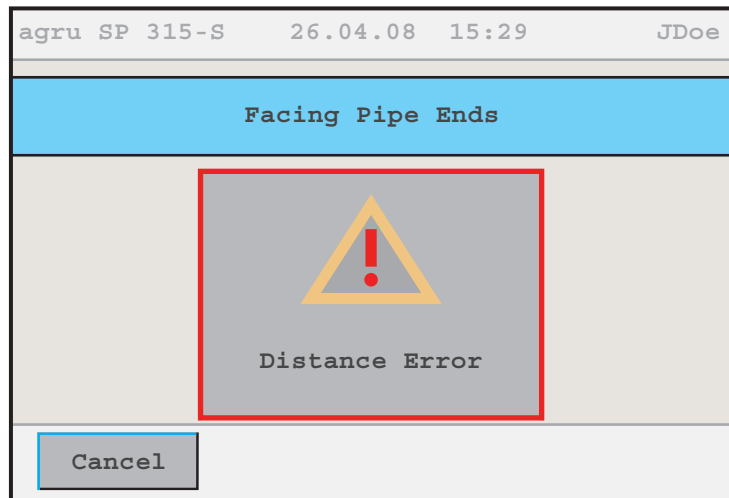

Display 17

The error that made the welding abort is displayed on the screen (see Display 17). Additionally, the LED icon in the welding diagram that belongs to the welding phase with the malfunction turns red.

The errors listed in the following table can be displayed on the screen.

Type of Error	Description
a. Data Input	
Input Error	Error while entering data on the touchscreen.
Code Error	Error while reading data from a bar code.
b. System	
Clock Error	The internal clock of the machine is defective; re-set the clock in the configuration menu.
Transport Lock	The transport lock were not removed before switching the machine on (see sections 3 and 4.1).
Power Supply Error	The rotating field of the power supply plug is incorrect. Two phases have to be inverted (see section 3.3). It is also possible that excessive or insufficient voltage was detected before or during the welding process.
System Error	Malfunction in the control system of the machine; power to the machine has to be turned off and unplugged immediately, and the machine has to be sent to the manufacturer or an authorized service point for check and repair.
Printer not Ready	The printer or PC connected to the machine is not ready (no communication, faulty cable or – if serial interface – bad interface configuration).
Unit Maintenance Due	The recommended service interval for the machine is over. It should be sent to the manufacturer or an authorized service point for scheduled maintenance and service.
No Function Available	A control (touchscreen button, switch) was used for which no function is defined.
c. Welding Process	
Ambient Temperature Error	The ambient temperature is out of the acceptable range from 0°C through to 40°C; welding is not possible.

Distance Error	The stroke of the carriage (at facing, change-over, or joining) does not correspond to the expected distance it should travel; welding has to be repeated.
Force Error	The applied force is out of tolerance; welding has to be repeated.
Power Supply Failure	In the course of the last welding operation, a power supply failure occurred; welding has to be repeated.
Emergency Stop	The welder has turned the machine off using the Emergency Stop switch. If this was done because of a malfunction of the machine, it must not be turned on again, unless it is beyond doubt that it works properly.
Mirror Temperature Low	The mirror temperature is out of tolerance and cannot be adjusted; as long as this error is not cleared, welding or repeating a welding operation is not possible.

5 Printing and Transferring Welding Reports

The machine is equipped with USB A interface that gives you the opportunity to connect the tag printer or, if permitted, a USB stick and a USB B interface through which data can be transferred to a PC, e.g. with an installation of the DataWork agru software.

5.1 The Print Menu and Printing/Transferring Reports

When a data communication cable is connected while the standard data screen (see Display 5) is showing, the machine displays the print menu. According to the selection made on this menu, data will be sent to the connected device: to the a printer for print-out or to a PC for further processing and archiving.

Touch the appropriate button to select printing “All Reports”, printing “By Commission Number”, or printing “By Date”.

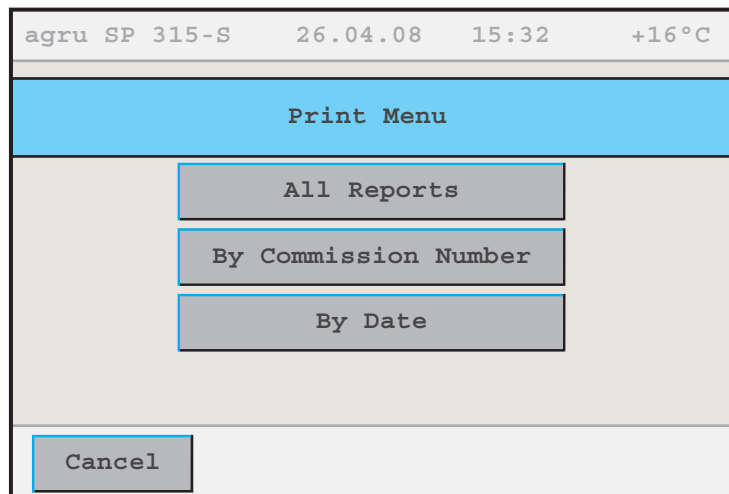

Display 18

The option “All Reports” causes all the welding reports stored in system memory to be printed. While the machine transfers the reports, a count-down indicates how many of them remain to be printed or transferred.

The options “By Commission Number” and “By Date” lead the operator to the next screen in which arrow buttons can be used to browse through the reports in system memory to select the desired commission or date from which reports should be printed or transferred (see Display 19). The options show the first available commission number or date, and once the desired one is found, the selection has to be confirmed by “Ok” to start the transfer to printer or PC.

If the machine displays a “Printer not Ready” error message after you touched the “Ok” button, the printer has to be switched to on-

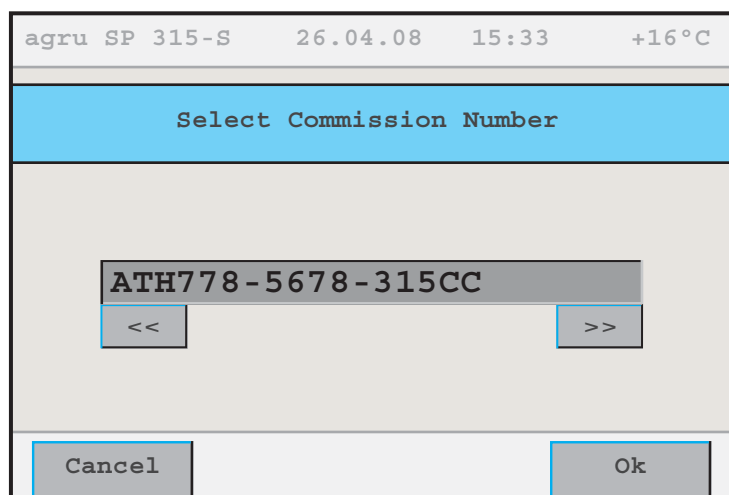

Display 19

line mode. Check for potentially damaged connections from the machine to the printer or the PC.

After successful printing, the machine displays a message telling the welder that printing was o.k.

5.2 Showing Reports in Memory, Reprinting Tags

Using the appropriate option of the configuration menu (see section 4.3), it is possible to display on the screen the welding reports saved to memory. A screen like the one in Display 20 appears. It is similar to the welding and traceability data overview shown at the end of each successful welding operation. The “Error” field reads “Ok” if no error occurred, and contains the acronym “PH” (for „Pre-Heat“) if the welding operation was performed with the pre-heating feature.

Near the left edge of the Report Info screen, you will find a list of all welding reports currently in memory. Above this list, the number of the selected report is given (before the slash), along with the total number of reports in memory (after the slash). To move the selector bar through the list, touch the scrollbar arrows to the right of the list. The longer you touch them, the faster the bar scrolls through the list.

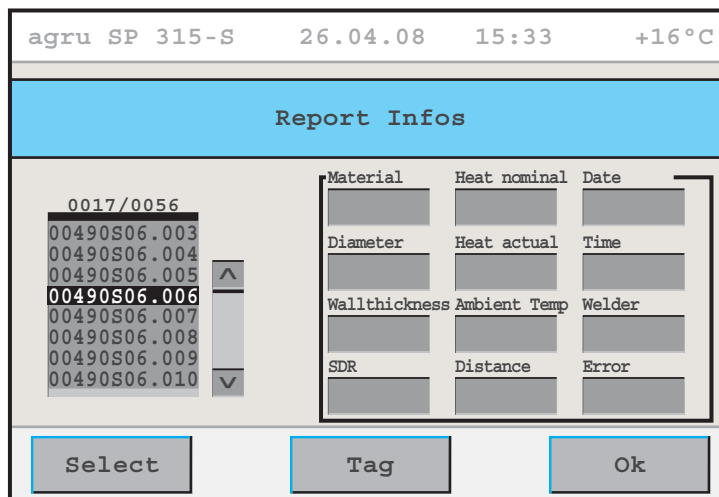

Display 20

To display the welding and traceability data of the selected report, touch the “Select” button after having selected it in the list. This will populate the fields in the right-hand part of the screen with the values saved to the selected welding report. To reprint an extra tag of this welding operation for sticking it onto the pipe, touch the “Tag” button.

5.3 Deleting Reports from Memory

To delete the reports stored in memory, use the appropriate option in the configuration menu (see sub-section 4.3). Upon touching this button, a safety warning asking if you really want to delete them appears on the screen and has to be confirmed to effectively delete the reports currently in memory.

6 System Data

6.1 Setting the Date and the Time of Day

When the “Date/Time” sub-menu was selected in the configuration menu (see sub-section 4.3), the screen shows what is reproduced in Display 21.

The time of day and the date can be set using the keypad shown on the touchscreen panel.

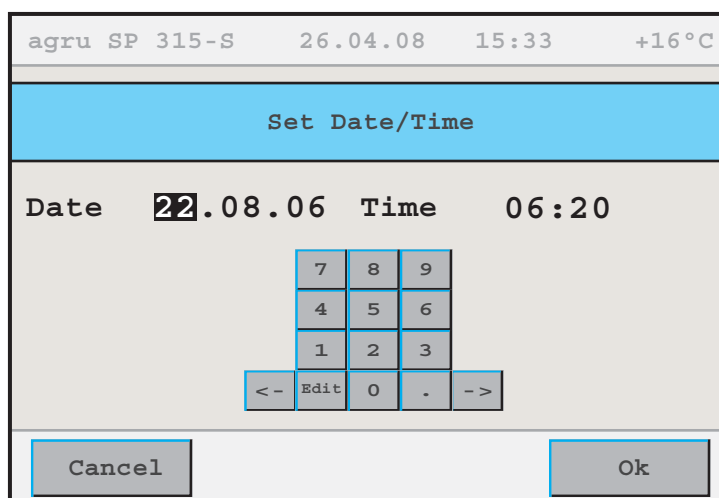

Display 21

6.2 Enabling Automatic Heating

When the “Automatic Heating” sub-menu was selected in the configuration menu (see sub-section 4.3), the screen shows what is reproduced in Display 22.

This feature allows preprogramming a date and time-of-day when the heating element must start heating up. This gives you the possibility, e.g., to enter this evening a time for the following morning and, then, to start welding right after arriving at the worksite instead of waiting for the heating element to reach the appropriate temperature.

For the automatic heating feature to work, the welding machine has to be connected to the power supply and be switched on all the time from preprogramming a time-of-day to the start of heating. Both power supply failure and switching the machine off result in loss of the preset time.

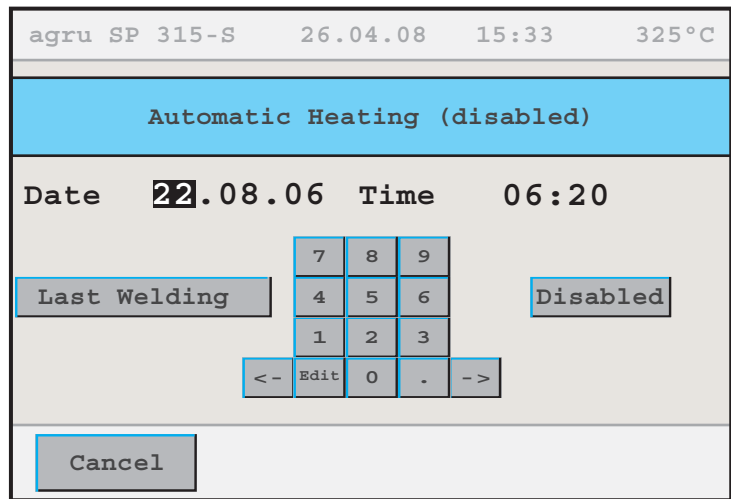

Display 22

Enter the desired date and time-of-day on the keypad (after each input, the machine moves on to the next field automatically), then touch the “Disabled” button. This button shows the current status of the automatic heating; when you touch it, it changes from “Disabled” to “Enabled” as the automatic heating feature is now on.



Important

Enabling the automatic heating feature should be the last action before you leave the worksite. For it causes the power supply to the heating element to be stopped, it cools down, and the screen displays only the automatic heating data. An exception to this is enabling the automatic heating feature using also the “Last Welding” feature.

If after setting the date and time-of-day for the heating element to heat up automatically, you touch the „Enabled“/„Disabled“ button and additionally the “Last Welding” button, the automatic heating feature is enabled and one more welding can be performed (see sections 4.2 ff.). This means that in this case enabling automatic heating need not be the last action before leaving and the heating element does not cool down after automatic heating was enabled. In this way, the welder can leave the worksite when the weld joint cools down after the last welding of the day. When the appropriate cooling time is completed, force to the the joined pipe is automatically canceled and the screen keeps the display that asks the welder to remove the welded joint from between the clamps.

If automatic heating was enabled, no matter whether by the “Enabled”/“Disabled” button alone or in combination with the “Last Welding” button, it makes sure that the heating element starts heating at the preset time-of-day and switches itself off after reaching the set temperature.

7 Service and Repair

As the machine is used in applications that are sensitive to safety considerations, it may be serviced and repaired only on our premises or by partners who were specifically trained and authorized by us, excepting the maintenance steps given below. Thus, constantly high standards of operation quality and safety are maintained.



Important

Non-compliance with this provision will dispense the manufacturer from any warranty and liability claims for the unit and any consequential damage.

All machines that are new or newly programmed during maintenance or upon request is wished are shipped with the most recent software version.

Lubrication of

- BallGuideBushings

- RunnerBlocks

- DriveSpindle

The 4 ball guide bushings of the support console of the facing tool and heating element and the 2 runner blocks of the heating element and 4 runner blocks of the facing tool, as well as the 4 runner block of the movable carriage of the machine (see the photos and the machine description in section 3) have to be lubricated regularly, every 12 months.

The same holds for the ball-bearing drive spindle ensuring longitudinal movement of the support console, which is accessible in the equipment and storage cabinet. **However, this spindle must only be lubricated by trained staff.** Damage due to inadequate, improper, or lack of lubrication are not eligible for warranty.

Lubricant and lubricant gun, which both are fully matched to the lubrication the machine needs, can be ordered with the manufacturer/distributor. **It is unacceptable to use other lubricants than the dedicated product approved of by the manufacturer.** The application of common grease products or widely available general lubricants may cause serious damage to the machine and make it unfit for further use.

In the equipment and storage cabinet you will also find the fuses and the automatic safety switch for the heating element, facing tool, and facing tool motor.

7 Service and Repair Contact

Asahi/America
655 Andover St.
Lawrence, MA 01843
1-800-343-3618
asahi@asahi-america.com

We reserve the right to change technical specifications of the unit without prior notice.

Info



Another Corrosion Problem Solved.™



Tel: 800-343-3618; 781-321-5409

Direct Sales: East (800) 232-7244
Central (800) 442-7244
West (800) 282-7244

Fax: 800-787-6861

www.asahi-america.com

asahi@asahi-america.com