

Serial No.	H-V028-E-20
------------	-------------

Diaphragm Valves Type 14

True Union Diaphragm Valves Type 14

User's Manual



Contents





- (1) Be sure to read the following warranty clauses of our product 1
- (2) General operating instructions 2
- (3) General instructions for transportation, unpacking and storage 2
- (4) Name of parts 3
 - Nom. Size 15-50mm (1/2"-2") 3
 - Nom. Size 15-50mm (1/2"-2") with limit switch 4
 - Nom. Size 65-100mm (2 1/2"-4") 5
 - Nom. Size 65-100mm (2 1/2"-4") with limit switch 6
- (5) Working pressure vs. temperature 7
- (6) Specification of limit switch 8
- (7) Installation procedure 8
 - Flanged end (PVC, C-PVC, PP, PVDF) 9
 - Threaded end (PVC, C-PVC, PP, PVDF) 10
 - Socket end (PVC, C-PVC) 11
 - Socket end & Spigot end (PP, PVDF) 12
- (8) Connection of limit switch procedure 13
- (9) Operating procedure 14
- (10) Operating procedure of locking device 15
- (11) Adjustment procedure for stopper 16
 - Nom. Size 15-50mm (1/2"-2") 17
 - Nom. Size 65-100mm (2 1/2"-4") 18
- (12) Diaphragm replacement procedure 19
- (13) Mounting an inserted metal and a base (panel) 20
- (14) Inspection items 21
- (15) Troubleshooting 21
- (16) Handling of residual and waste materials 21

This user's guide contains very important information for the proper installation, maintenance and safe use of an ASAHI AV Product. Please store this manual in an easily accessible location.

<Warning & Caution Signs>

 Warning	This symbol reminds the user to take caution due to the potential for serious injury or death.
 Caution	This symbol reminds the user to take caution due to the potential for damage to the valve if used in such a manner.





<Prohibited & Mandatory Action Signs>

	Prohibited: When operating the valve, this symbol indicates an action that should not be taken.
	Mandatory action: When operating the valve, this symbol indicates mandatory actions that must be adhered to.





(1) Be sure to read the following warranty clauses of our product

- Always observe the specifications of and the precautions and instructions on using our product.
- We always strive to improve product quality and reliability, but cannot guarantee perfection. Therefore, should you intend to use this product with any equipment or machinery that may pose the risk of serious or even fatal injury, or property damage, ensure an appropriate safety design or take other measures with sufficient consideration given to possible problems. We shall assume no responsibility for any inconvenience stemming from any action on your part without our written consent in the form of specifications or other documented approval.
- The related technical documents, operation manuals, and other documentation prescribe precautions on selecting, constructing, installing, operating, maintaining, and servicing our products. For details, consult with our nearest distributor or agent.
- Our product warranty extends for one and a half years after the product is shipped from our factory or one year after the product is installed, whichever comes first. Any product abnormality that occurs during the warranty period or which is reported to us will be investigated immediately to identify its cause. Should our product be deemed defective, we shall assume the responsibility to repair or replace it free of charge.
- Any repair or replacement needed after the warranty period ends shall be charged to the customer.
- The warranty does not cover the following cases:
 - (1) Using our product under any condition not covered by our defined scope of warranty.
 - (2) Failure to observe our defined precautions or instructions regarding the construction, installation, handling, maintenance, or servicing of our product.
 - (3) Any inconvenience caused by any product other than ours.
 - (4) Remodeling or otherwise modifying our product by anyone other than us.
 - (5) Using any part of our product for anything other than the intended use of the product.
 - (6) Any abnormality that occurs due to a natural disaster, accident, or other incident not stemming from something inside our product.

(2) General operating instructions

- 

Warning
 - Using a positive-pressure gas with our plastic piping may pose a dangerous condition due to the repellent force particular to compressible fluids even when the gas is under similar pressures used for liquids. Therefore, be sure to take the necessary safety precautions such as covering the piping with protective material. For inquiries, please contact us. For conducting a leak test on newly installed piping, be sure to check for leaks under water pressure. If absolutely necessary to use a gas in testing, please consult your nearest service station beforehand.
- 

Caution
 - Do not step on or apply excessive weight on valve. (It can be damaged.)
 - Do not use the valve in conditions where the fluid may have crystallized. (The valve will not operate properly.)
- 
 - Keep the valve away from excessive heat or fire. (It can be damaged, or destroyed.)
 - Always operate the valve within the pressure vs. temperature range. (The valve can be damaged or deformed by operating beyond the allowable range.)
 - Allow sufficient space for maintenance and inspection.
 - Select a valve material that is compatible with the media. For chemical resistance information, refer to “CHEMICAL RESISTANCE ON ASAHI AV VALVE”. (Some chemicals may damage incompatible valve materials.)
 - Keep the valve out of direct sunlight, water and dust. Use cover to shield the valve. (The valve will not operate properly.)
 - Perform periodic maintenance. (Leakage may develop due to temperature changes or periods of prolonged storage, rest, or operation.)
 - The travel stop may have to be adjusted if media leakage is detected between the upstream & downstream sides of the valve.
 - Bonnet bolt torque should be checked before installation, as they may become loose after long-term storage.
 - A periodic check of the valve condition as well as bonnet & flange bolt torque should be made part of preventative maintenance program properly re-tightening the bolts as necessary. It is especially important to re-tighten all bolts during the first shutdown.

(3) General instructions for transportation, unpacking and storage

- 

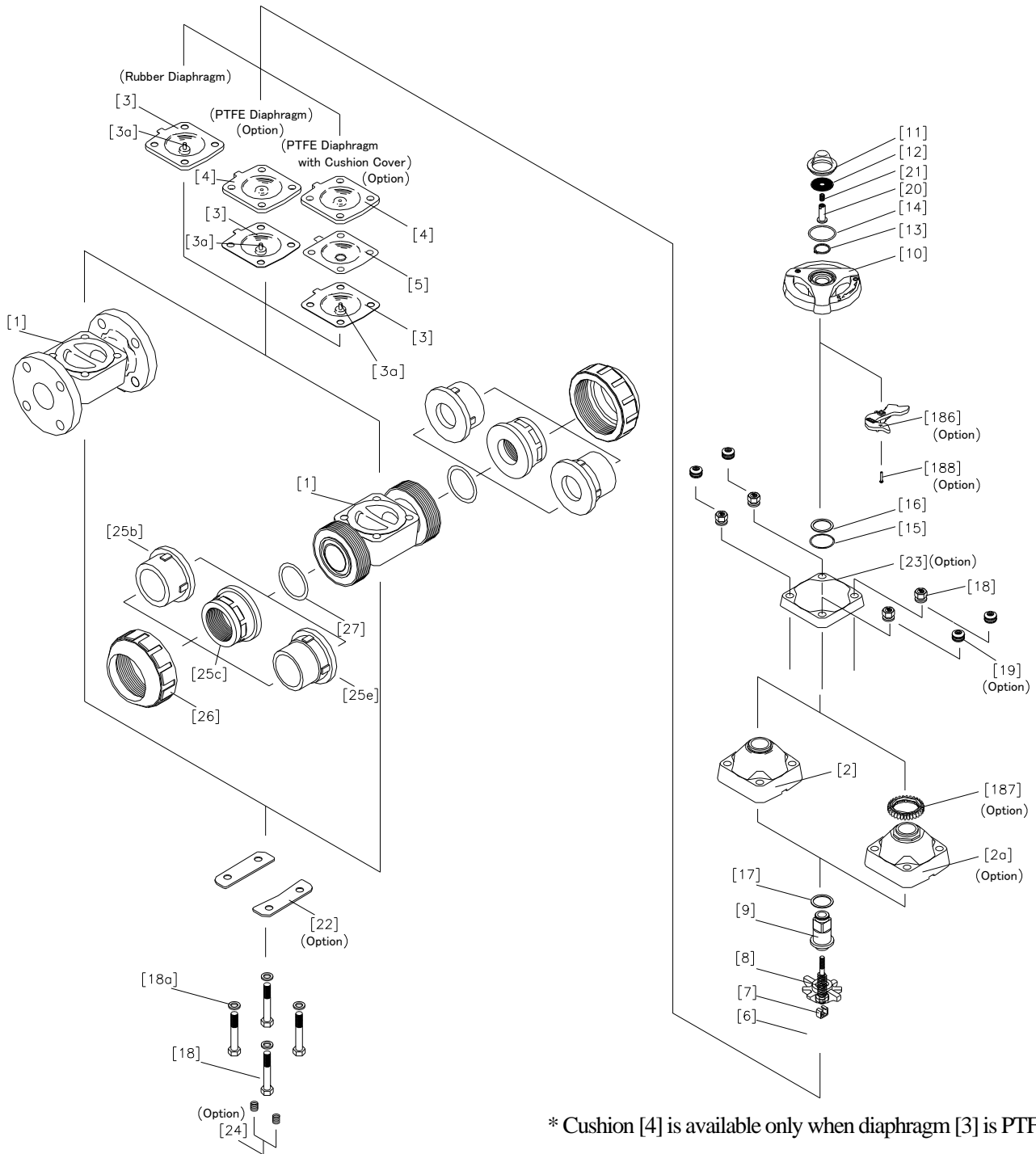
Warning
 - When suspending and supporting a valve, take care and do not stand under a suspended valve.
- 

Caution
 - This valve is not designed to handle impacts of any kind. Avoid throwing or dropping the valve.
 - Avoid scratching the valve with any sharp object.
 - Do not over-stack cardboard shipping boxes. Excessively stacked packages may collapse.
 - Avoid contact with any coal tar creosote, insecticides, vermicides or paint. (These chemicals may cause damage to the valve.)
- 
 - Store products in their corrugated cardboard boxes. Avoid exposing products to direct sunlight, and store them indoors (at room temperature). Also avoid storing products in areas with excessive temperatures. (Corrugated cardboard packages become weaker as they become wet with water or other liquid. Take care in storage and handling.)
 - After unpacking the products, check that they are defect-free and meet the specifications.

(4) Name of parts

Nominal size: 15 - 50mm (1/2" - 2")



No.	DESCRIPTION	No.	DESCRIPTION	No.	DESCRIPTION
[1]	Body	[11]	Gauge Cover	[22]	Body Liner
[2]	Bonnet	[12]	Name Plate	[23]	Liner
[2a]	Bonnet(Handle lock)	[13]	Retaining Ring C-Type	[24]	Metal Insert (Ensat)
[3]	Diaphragm	[14]	O-ring (A)	[25b]	End Connector (Socket End)
[3a]	Inserted Metal of Diaphragm	[15]	O-ring (B)	[25c]	End Connector (Threaded End)
[4]	Cushion	[16]	Thrust Ring (A)	[25e]	End Connector(Spigot End)
[5]	Cushion Cover	[17]	Thrust Ring (B)	[26]	Union Nut
[6]	Compressor	[18]	Bolt, Nut	[27]	O-ring (C)
[7]	Joint	[18a]	Washer	[186]	Locking Lever
[8]	Stem	[19]	Conical Spring Washer	[187]	Locking Plate
[9]	Sleeve	[20]	Stopper(A)	[188]	Tapping Screw
[10]	Hand Wheel	[21]	Screw		

Nominal size: 15 - 50mm ($\frac{1}{2}$ " - 2") with Limit Switch (Option)

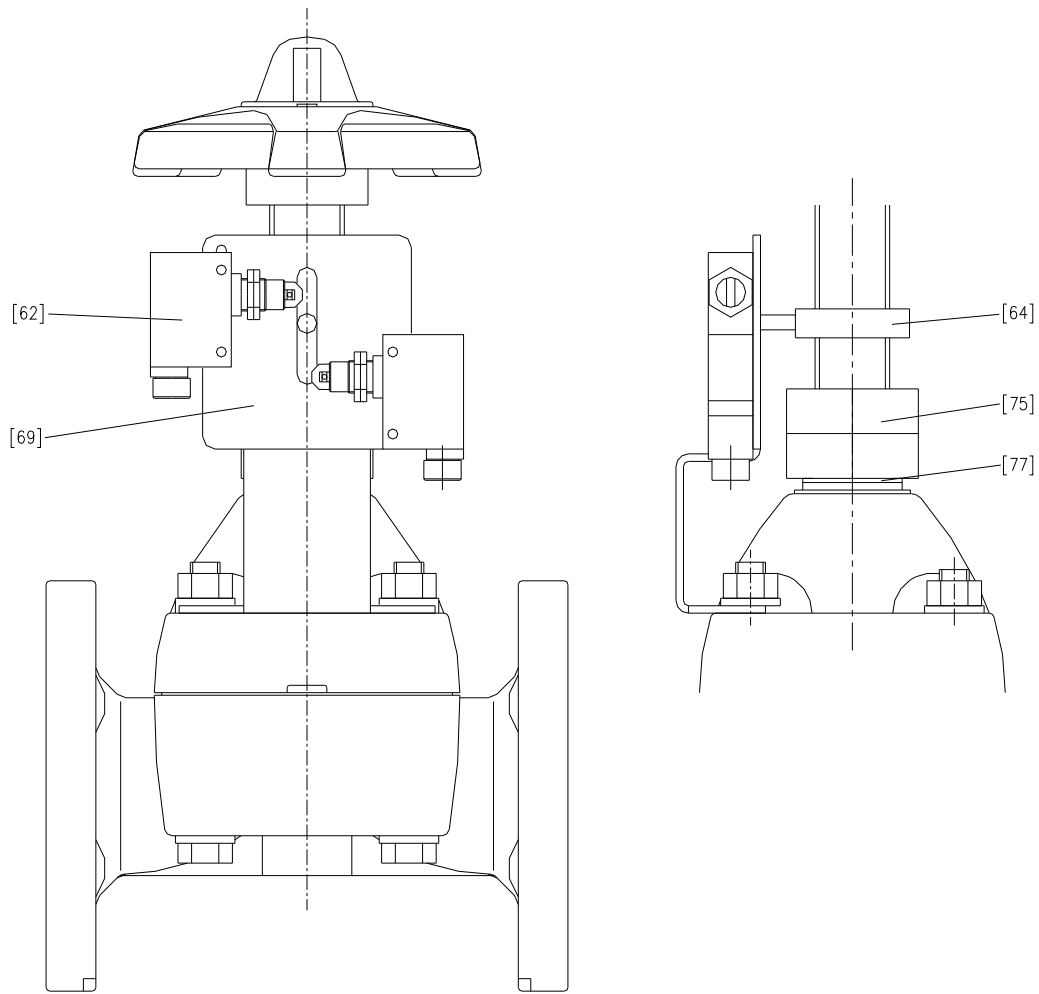

No.	DESCRIPTION	No.	DESCRIPTION
[62]	Limit Switch	[75]	Nut (C)
[64]	Limit Switch Pushing Plate	[77]	Thrust Ring (C)
[69]	Bracket (A)		

Nominal size: 65 - 100mm (2 1/2 - 4")

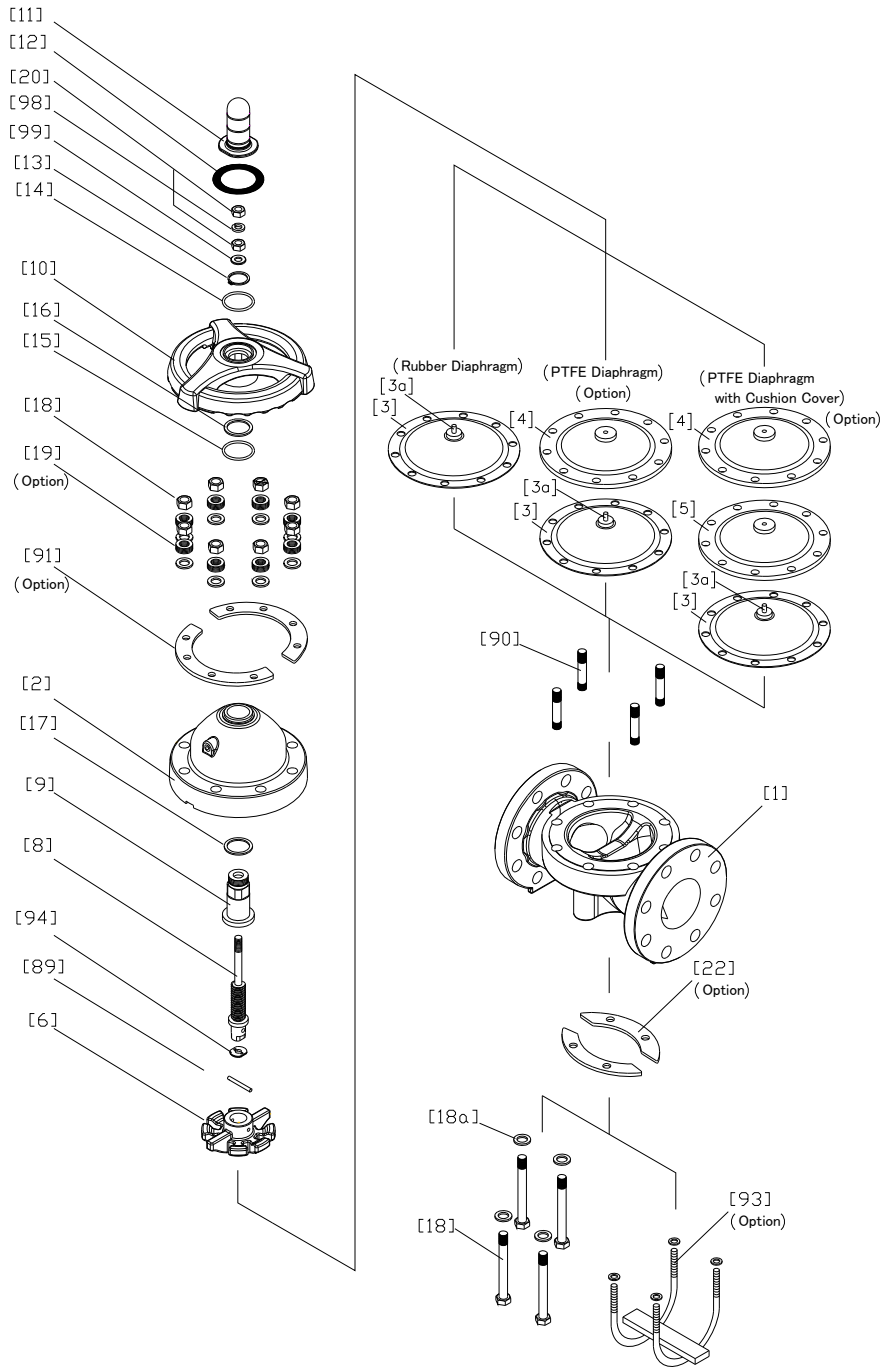

* Cushion [4] is available only when diaphragm [3] is PTFE.

No.	DESCRIPTION	No.	DESCRIPTION	No.	DESCRIPTION
[1]	Body	[11]	Gauge Cover	[20]	Stopper
[2]	Bonnet	[12]	Name Plate	[22]	Body Liner
[3]	Diaphragm	[13]	Retaining Ring C-Type	[89]	Compressor Pin
[3a]	Inserted metal of Diaphragm	[14]	O-ring (A)	[90]	Stud Bolt • Nut
[4]	Cushion	[15]	O-ring (B)	[91]	Upper Bonnet Liner
[5]	Cushion Cover	[16]	Thrust Ring (A)	[93]	U-Bolt • Nut
[6]	Compressor	[17]	Thrust Ring (B)	[94]	Metal of Compressor
[8]	Stem	[18]	Bolt, Nut	[98]	Spring Washer
[9]	Sleeve	[18a]	Washer (A)	[99]	Valve Sheet
[10]	Hand Wheel	[19]	Conical Spring Washer (A)		

Nominal size: 65 - 100mm (2 1/2" - 4") with Limit Switch (Option)

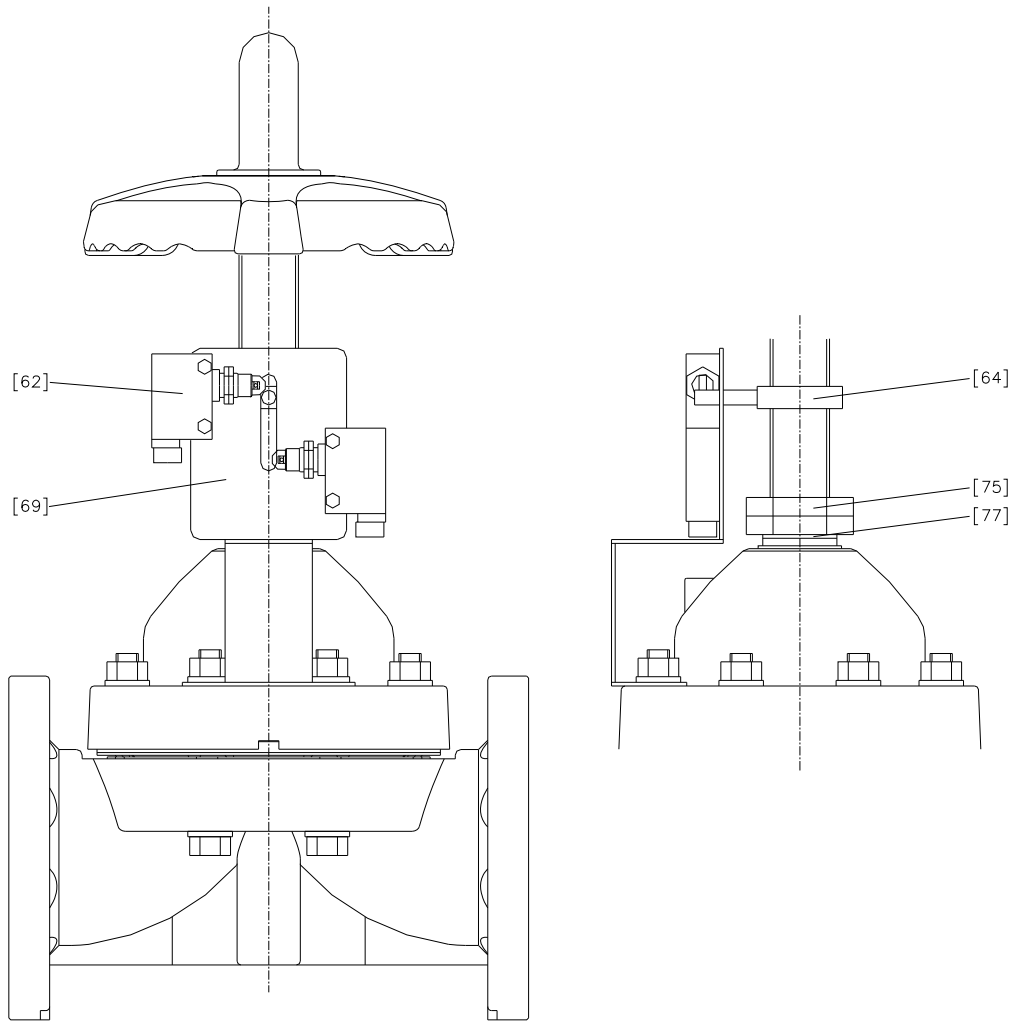

No.	DESCRIPTION	No.	DESCRIPTION
[62]	Limit Switch	[75]	Nut (C)
[64]	Limit Switch Pushing Plate	[77]	Thrust Ring (C)
[69]	Bracket (A)		

(5) Working pressure vs. temperature

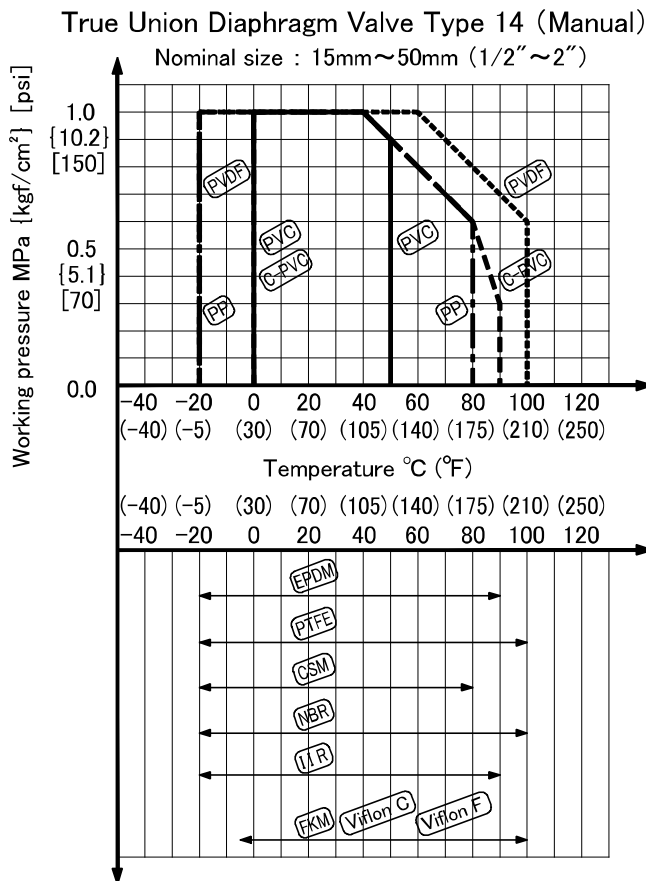
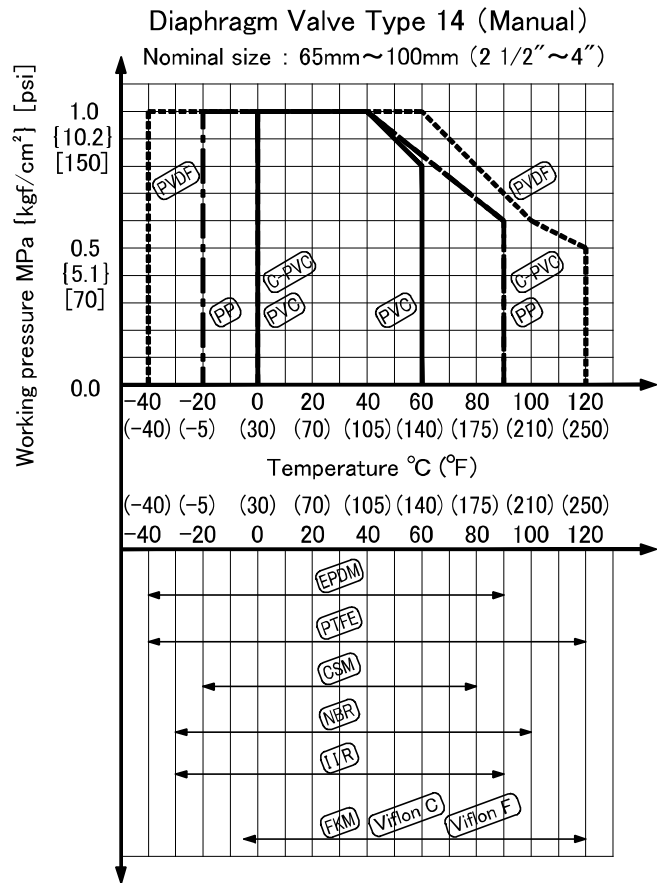
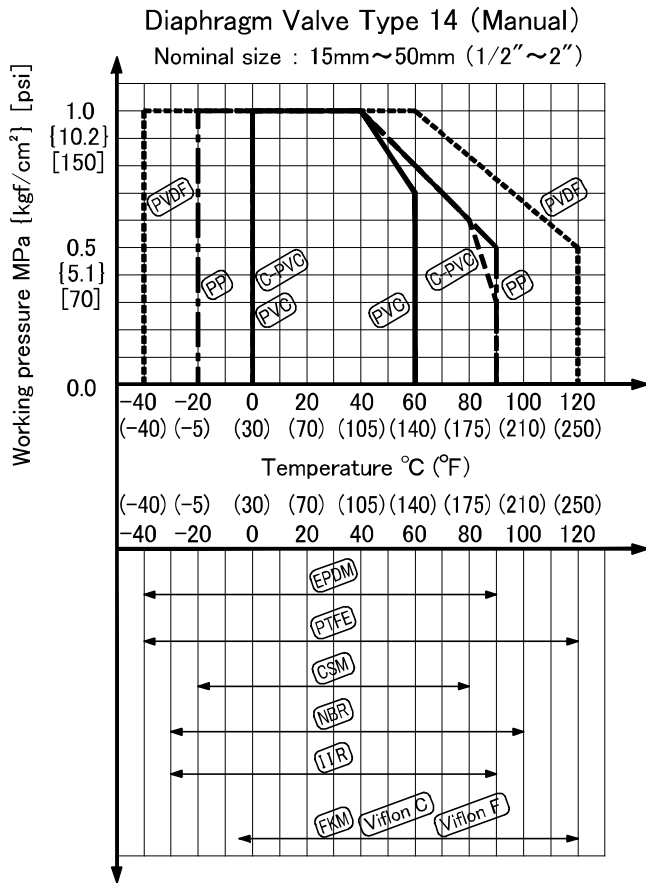

(6) Specification of Limit Switch (Option)

Nominal Size	Type Code	Protection Grade
15 - 100mm (1/2 - 4")	SL1-A	IP67

Limit Switch Rating

Rate Voltage (V)	Resistive Load (A)	Inductive Load (A)
AC125	5	3
AC250	5	3
DC8	5	3
DC14	5	3
DC30	5	3
DC115	0.5	0.1
DC230	0.25	0.05

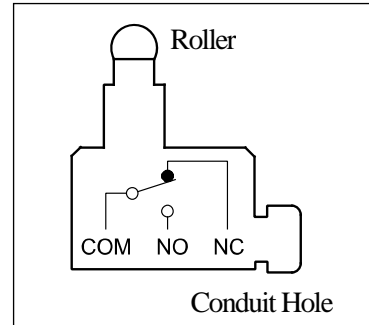

Connection Diagram



(7) Installation procedure

- Warning** (Warning icon: exclamation mark in a triangle, crossed out by a red circle with a diagonal line)
- When suspending and supporting a valve, take care and do not stand under a suspended valve.
- !** (Warning icon: exclamation mark in a blue circle)
- Be sure to conduct a safety check on all hand and power tools to be used before beginning work.
 - Wear protective gloves and safety goggles as fluid remain in the valve even if the pipeline is empty. (You may be injured.)
- Caution** (Caution icon: exclamation mark in a yellow triangle, crossed out by a red circle with a diagonal line)
- When installing a pipe support by means of a U-band or something similar, take care not to over-tighten. (Excessive force may damage the pipe.)
 - When installing pipes and valves, ensure that they are not subjected to tension, compression, bending, impact, or other excessive stress.
 - When installing, disassembling, or reassembling the piping, fix the End Connector.
 - Before a water test, be sure that the Union Nut is tightly fastened.
 - Fasten the Union Nut while avoiding the parallelism and axial misalignment of the flange surface.
 - When connecting an ASAHI AV Valve to metal piping, take care not to let the pipe stress on the ASAHI AV Valve.
 - Take care not to over-tighten the Union Nut. (The valve can be damaged.)
 - Do not use the pipe wrench. (The valve can be damaged.)



Flanged end (End connector materials: PVC, C-PVC, PP, PVDF)

Caution   - Use flat faced flanges for connection to AV Valves.
 - Ensure that the mating flanges are of the same standards.
 - Be sure to use sealing gaskets (AV Gasket), bolts, nuts, and washers and tighten them to specified torques.
 (When a non-AV gasket is used, a different tightening torque specification should be followed.)

- Necessary items
- Torque wrench
 - AV gasket
 - Spanner wrench
 - Bolt, Nut, Washer (For many flanges specification)

Procedure

- 1) Set the AV gasket between the flanges.
- 2) Insert washers and bolts from the pipe side, insert washers and nuts from the valve side, then temporarily tighten them by hand.



Caution   - The parallelism and axial misalignment of the flange surface should be under the values shown in the following table to prevent damage the valve.
 (A failure to observe them can cause destruction due to stress application to the pipe)

Unit : mm (inch)

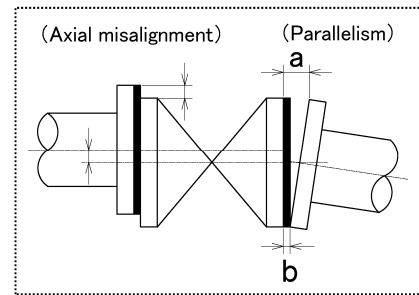
Nom. Size	Axial misalignment	Parallelism (a-b)
15 - 32mm (1/2" - 1 1/4")	1.0 (0.04)	0.5 (0.02)
40, 50mm (1 1/2", 2")	1.0 (0.04)	0.8 (0.03)
65 - 100mm (2 1/2" - 4")	1.0 (0.04)	1.0 (0.04)



- 3) Tighten the bolts and nuts gradually with a torque wrench to the specified torque level in a diagonal manner. (Refer to Fig.1.)
- 4) Tighten it more than 2 turns clockwise with specified torque. (Refer to Fig.1)



Caution   - Do not tighten at the specified torque or more. (The valve can be damaged or leak.)

Recommended torque value Unit: N·m {kgf·cm} [lb·inch]

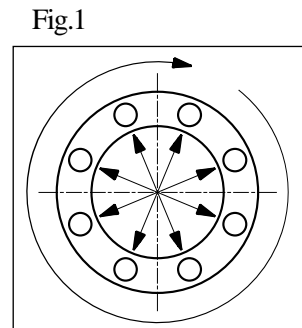
Nom. Size	15 - 20mm (1/2" - 3/4")	25 - 40mm (1" - 1 1/2")	50, 65mm (2", 2 1/2")	80, 100mm (3", 4")
PTFE·PVDF coated	17.5	20.0	22.5	30.0
	{179} [155]	{204} [177]	{230} [200]	{306} [266]
Rubber	8.0	20.0	22.5	30.0
	{82} [71]	{204} [177]	{230} [200]	{306} [266]



Threaded end (End connector materials: PVC, C-PVC, PP, PVDF)

Caution   - Avoid excessive tightening. (The valve can be damaged.)

 - Make sure that the threaded connections are plastic x plastic. (Metallic thread can cause damage.)

- Wrap the threaded joints on our plastic piping with sealing tape. (A non-sealing tape can cause leakage.)
 Using a liquid sealing agent or liquid gasket may cause stress cracks (Environmental Stress Cracking).
 Our product warranty shall not apply in case of said use, even when said use is unavoidable.

Necessary items





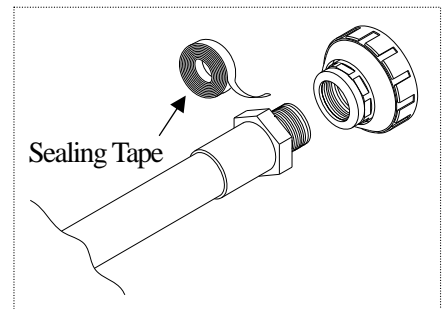

- Sealing tape
- Strap wrench
- Spanner wrench

Procedure

- 1) Wind a sealing tape around the external thread of joint, leaving the end (about 3mm) free.
- 2) Loosen the union nut [26] with a strap wrench.
- 3) Remove the union nut [26] and the end connector [25b].
- 4) Tighten the external thread of the joint and the end connector [25b] hardly with hand.
- 5) Using a spanner wrench, screw in the end connector [25b] by turning 180° - 360° carefully without damaging it.
- 6) Make sure that the O-ring (C) [27] is mounted.
- 7) Set the end connector [25b] and union nut [26] directly on the body without allowing the O-ring (C) [27] to come off.
- 8) Tighten union nut [26] on each valve until hand tight.
- 9) Using a strap wrench tighten union nuts uniformly on each side approx 90° - 180° turns, 1/4 to 1/2 turns.



Socket end (End connector materials: PVC,C-PVC)



-   - When using an adhesive, ventilate the space sufficiently, prohibit the use of a fire in the vicinity, and do not inhale adhesive vapors directly.
-  - If an adhesive gets into contact with your skin, wash it off immediately.
If you feel sick or find any anomaly, receive a physician's diagnosis and take appropriate measures promptly.
-   - Take care in doing work at low temperatures. Solvent vapors are hard to evaporate and are likely to remain. (Solvent cracks may occur, damaging the equipment.) After assembling the piping system, open both ends of the piping and use a fan (of the Low-Voltage Type) or something similar to ventilate the space, thus removing the solvent vapors.
-  - Use the appropriate Asahi AV cement.
- Conduct a water test at least 24 hours after joining the pipes with an adhesive.

Necessary items

- AV cement
- Strap wrench.

Procedure



- 1) Loosen the union nut [26] with a strap wrench.
- 2) Remove the union nut [26] and end connector [25b].
- 3) Lead the union nut through the pipe.
- 4) Clean the hub part of the end connector [25b] by wiping with a waste cloth.
- 5) Apply adhesive evenly to the hub part of the end connector [25b] and the pipe spigot.

-   - Do not apply more adhesive than necessary. (The valve can be damaged due to solvent cracking.)

Adhesive quantity (guideline)

Nom. Size	15mm (1/2")	20mm (3/4")	25mm (1")	32mm (1 1/4")	40mm (1 1/2")	50mm (2")	65mm (2 1/2")	80mm (3")	100mm (4")
Quantity (g)	1.0	1.3	2.0	2.4	3.5	4.8	6.9	9.0	13.0

- 6) After applying adhesive, insert the pipe quickly to the end connector [25b] and leave it alone for at least 60 seconds.

-   - Do not under any circumstances try to insert a pipe into another fitting or valve by striking it, which may break the piping.

- 7) Wipe away overflowing adhesive.
- 8) Make sure that O-ring (C) [27] is mounted
- 9) Tighten union nut [26] on each valve until hand tight.
- 10) Using a strap wrench tighten union nuts uniformly on each side approx. 90° - 180° turns, 1/4 to 1/2 turns.

Socket end & Spigot end (End connector materials: PP, PVDF)



Necessary items

- Strap wrench
- Welding machine
- User's manual for welding machine

Procedure

- 1) Loosen the union nut with a strap wrench.
- 2) Remove the union nut [26] and the end connector [25b].
- 3) Lead the union nut [26] through the pipe.
- 4) For the next step, refer to the user's manual for the welding machine.
- 5) After welding, make sure that the O-ring (C) [27] is mounted.
- 6) Set the end connector [25b] and the union nut [26] directly without allowing the O-ring (C) [27] to come off.
- 7) Tighten union nut [26] on each valve until hand tight.
- 8) Using a strap wrench tighten union nuts uniformly on each side approx. 90° - 180° turns, 1/4 to 1/2 turns.

(8) Connection of limit switch procedure

-  **Warning** - Shut down the power on the equipment before connecting wires. There are risks of electrical shock depending on the level of operating voltage.
-  **Caution** - Connect the cables by using insulated sheathed crimping terminals in such a way as not to contact the cover or housing. (Contact of a crimping terminal with the cover may disable the cover from being closed or may cause a ground fault.)
- Be sure that the terminal cover and body cover are put on during the operation.

Necessary items

- Phillips head screw driver
- Flathead screw driver
- Connector (G1/2)
- Wire stripper
- Terminal crimping tool

Procedure

- 1) Adjust a cable as shown in the figure below. (When installing a crimp style terminal on the lead wire, use crimp style terminals with insulation sleeve (M3) so that, its does not contact the housing and other crimp style terminals.)

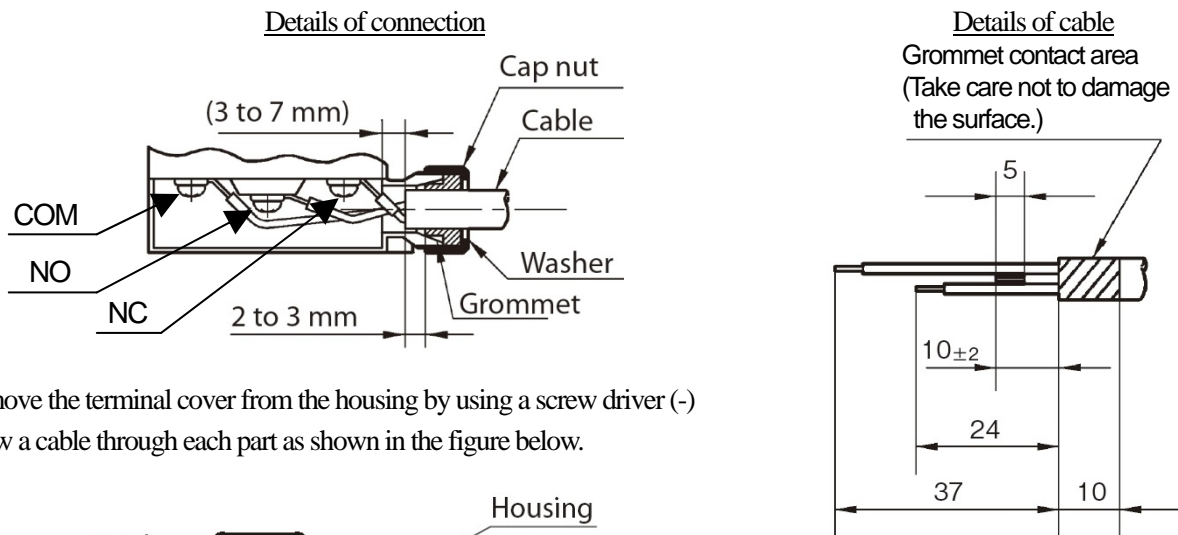

- 2) Remove the terminal cover from the housing by using a screw driver (-)
- 3) Draw a cable through each part as shown in the figure below.

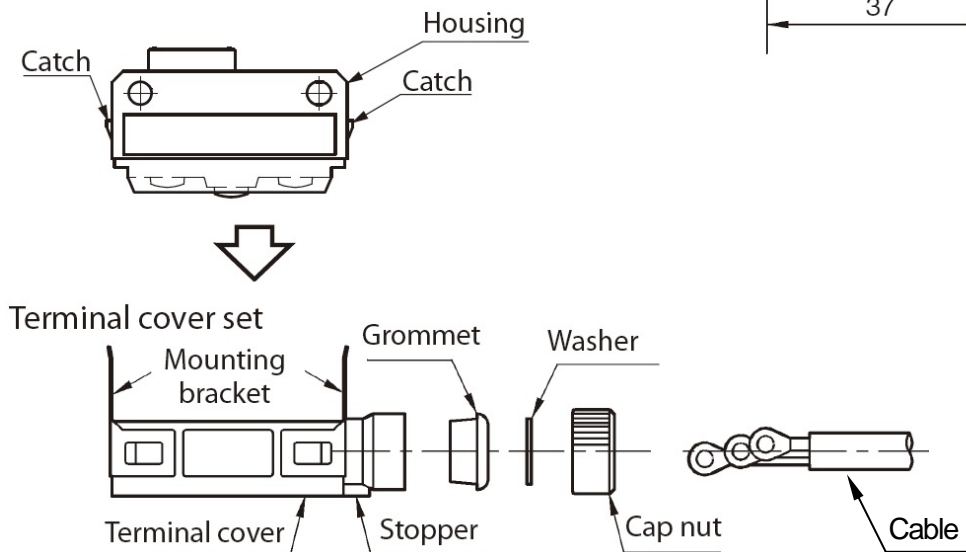

- 4) Connect the crimp style terminal to the terminal board with a screw driver (+).
- 5) Attach the terminal cover to the housing.
- 6) Set the seal and washer, and tighten the nut to the terminal cover.

(9) Operating procedure

Caution

- Do not exert excessive force in closing the valve.
- Do not use the valve to fluid containing slurry. (The valve will not operate properly.)
- The installed valve must never be opened or closed when foreign matter such as sand is present in the pipeline.
- When operating the handle, be sure to do so with your hand. (Using a tool may damage the handle.)
- Before opening or closing a lubricant free product, be sure to apply water.
- If a stopper is loose, adjust it. (To learn how to adjust it, see the operation manual.)

- Open and shut the valve by rotating handle wheel.
- The top of the travel stop will be flush with the top of the handle wheel when the valve is fully closed.

< Nominal size: 15-50mm (1/2"-2") >

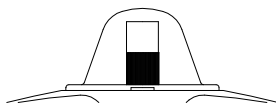

Full open

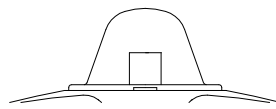

Half open

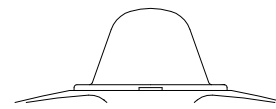

Full shut

< Nominal size: 65-100mm (2 1/2"-4") >

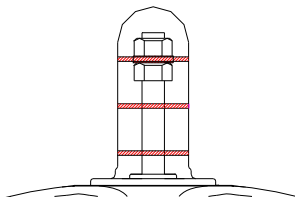

Full open

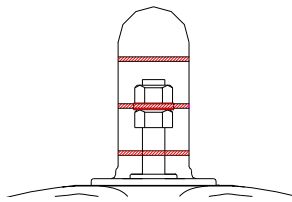



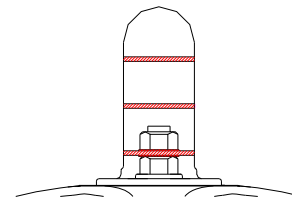

Half open



Full shut

(10) Operating procedure of locking device

- 
 • Do not exert excessive force in turning the handle. (It can be deformed, or destroyed.)
- 
 • Please lock using a padlock for misoperation prevention.
- 
 • The valve is simple locked at the time of shipment. Please operate valve after release simple lock.
- 
 • Do not disassemble the LOCKING DEVICE. (Injury may occur.)

1. Push the release lever with the locking hole to release the simple lock
2. Operate the valve to the desired valve lift.
3. Push the lock lever without the locking hole to lock the simple lock.
4. The location hole for the lock is already installed in the handle. Please lock using padlock as necessary. (Refer to Table 1 for the size of lock.)

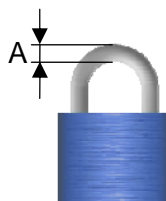
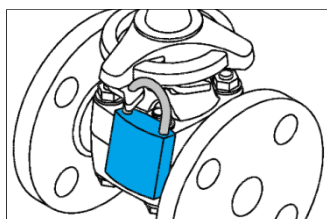
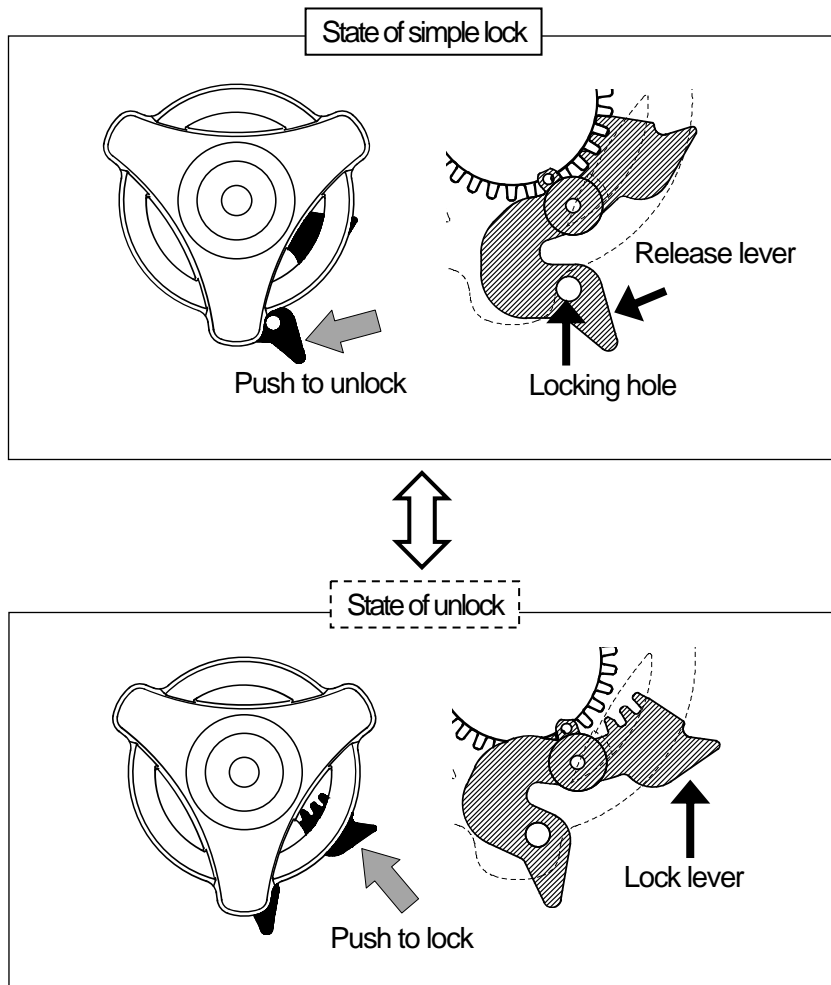



Table 1 <Size of Lock>

Nominal Size mm (inch)	A mm(inch)
15~32 (1/2-1 1/4")	5 (0.20")
40~50 (1 1/2- 2")	6 (0.24")

(11) Adjustment procedure for stopper

  - If a stopper is loose, adjust it. (To learn how to adjust it, see the operation manual.)

- Tighten the stoppers securely. (Too weak a torque on a stopper may cause it to loosen.)

Necessary items

- Spanner wrench
- Allen wrench
- Screw driver(-)
- Protective Gloves
- Goggles

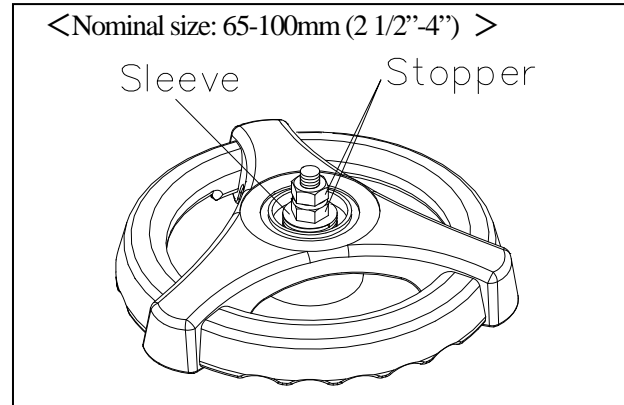
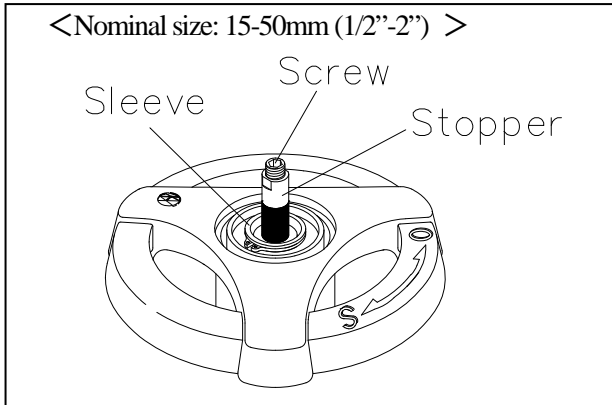

Travel stop adjustment

< Nominal size : 15-50mm (1/2"-2") >

① Turn valve handle clockwise to the full closed position.
Remove the gauge cover, being careful not to damage the gauge cover O-ring.

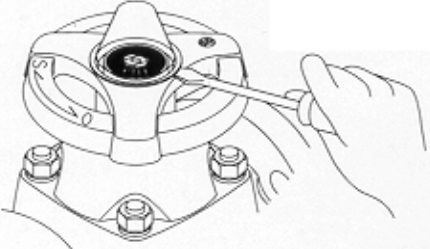

② Remove the travel stop / position indicator with a spanner wrench and loosen the axial set screw counterclockwise with an Allen wrench. The axial set screw is located within the brass travel stop looking down.

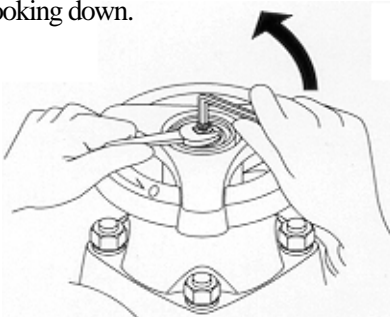

③ Loosen the travel stop counter-clockwise.

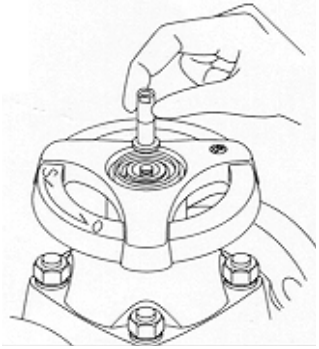

④ Slowly tighten the hand wheel clock wise until the leak-by stops.

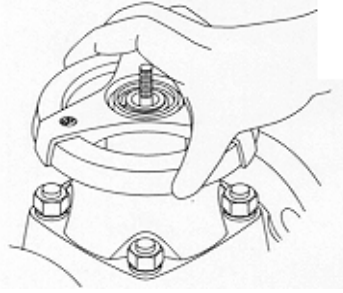

⑤ Tighten the travel stop clockwise until it stop and the turn it back (counter-clockwise) 180°.

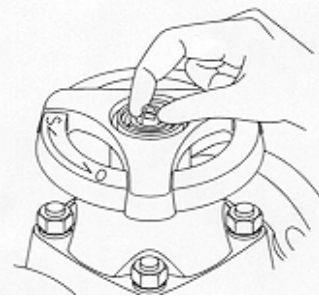

⑥ Secure the travel stop/position indicator with wrench and tighten the axial set screw clockwise with an Allen wrench.

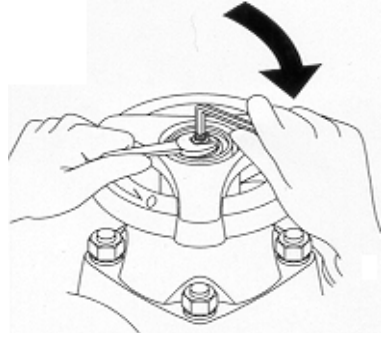

⑦ Re-attach the gauge cover.

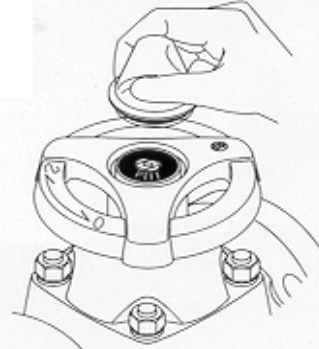

Tightening torque of the screw

Unit : N·m {kgf·cm} [lb·inch]

Nom. Size	15 - 32mm (1/2" - 1 1/4")	40, 50mm (1 1/2", 2")
Torque value	8.0 {81} [71]	12.0 {122} [106]

Travel stop adjustment

< Nominal size 65 - 100mm >

- 1) Loosen the gauge cover [11] with hand.
- 2) Loosen the upper nut [20] from the lower nut [20] with spanner wrench.
- 3) Loosen the lower nut [20].
- 4) Operate the handle wheel to tighten gradually until the leakage of fluid stops.
- 5) Tighten the lower nut [20] until it stop, and then turn it back (counter-clockwise) 180° .
- 6) Tighten the upper nut [20] to the lower nut [20] with spanner wrench.
- 7) Tighten the gauge cover [11].

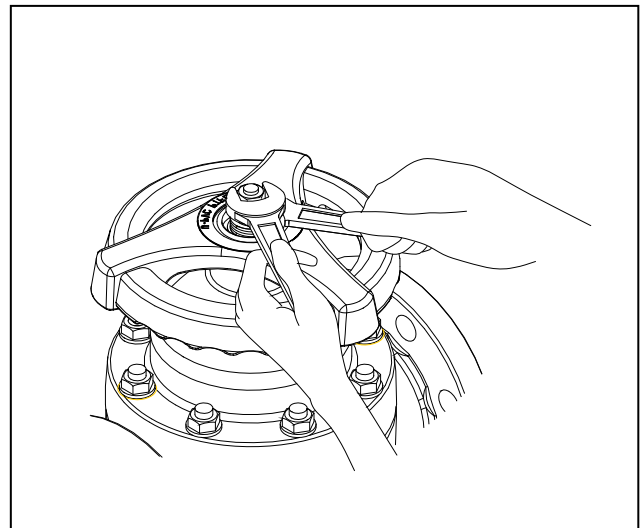
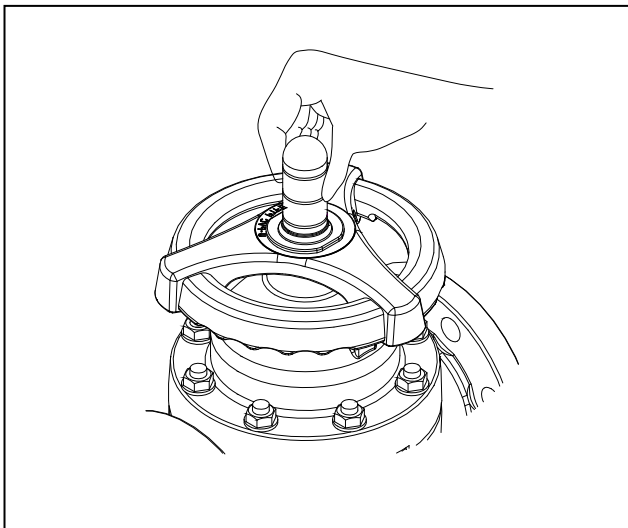



Tightening torque of the screw

Unit : N·m {kgf·cm} [lb·inch]

Nom. Size	65 - 100mm (2 1/2" - 4")
Torque valve	15.0 {153} [133]

(12) Diaphragm replacement procedure

  - If you do work with the piping installed, drain the piping of all its fluid. Some fluid will remain in the valve. Therefore wear protective goggles and protective gloves. (You may otherwise get injured.)

Necessary items

- Torque wrench
- Protective gloves
- Spanner wrench
- Goggles

- 1) Drain fluid completely from the pipe line.
- 2) Remove valve bonnet from the body.
- 3) Turn handle of valve clockwise until it stops. (Do not force it). The compressor should be fully extended out of the bonnet.
- 4) Bayonet connection type (standard)

Remove the diaphragm from the compressor by turning it 90° and mount the new diaphragm by reversing step.

Make sure that the pin of inserted metal of diaphragm connects joint completely.

* The standard is Bayonet type.

* After Diaphragm made of PTFE reverses installation difficulty and Diaphragm, it installs it.

* Whether the pin of the burial metal fittings of Diaphragm made it connect with Joint is confirmed.

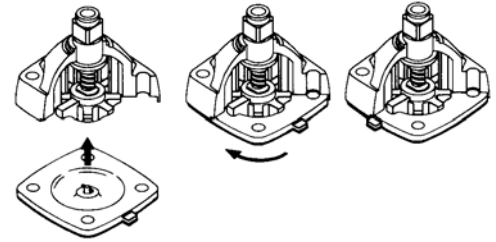

Bayonet connection

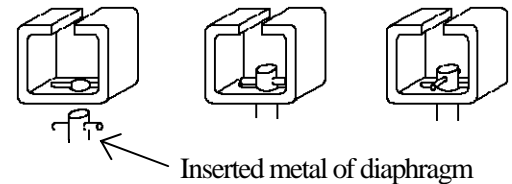

Threaded connection type

Turn the diaphragm clockwise to remove the diaphragm and mount the new diaphragm by reversing step.

Threaded connection

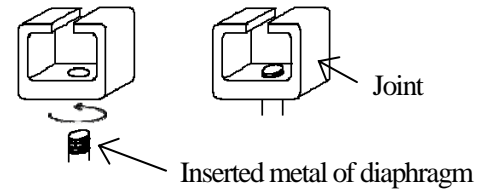

- 5) Mount the bonnet to the valve by reversing step 2. Tighten bonnet bolts by hand only.
- 6) Rotate the handle 360° counter-clockwise.
- 7) Using a torque wrench, tighten the bonnet bolts in a diagonal, cross-cross pattern.



Bonnet torque value

Unit : N·m{kgf·cm}[lb·inch]

Nom. Size Diaphragm	15, 20mm (1/2", 3/4")	25, 32mm (1", 1 1/4")	40mm (1 1/2")	50mm (2")	65mm (2 1/2")	80mm (3")	100mm (4")
Rubber	3.0 {31} [27]	5.0 {51} [44]	12.0 {122} [106]	15.0 {153} [133]	13.0 {133} [115]	18.0 {184} [160]	35.0 {357} 310
PTFE	5.0 {51} [44]	8.0 {82} [71]	15.0 {153} [133]	20.0 {204} [177]	15.0 {153} [133]	20.0 {204} [177]	40.0 {408} [355]

- 8) Re-adjust the stopper if necessary.

(13) Mounting an inserted metal, and a base (panel)

Caution   - When screwing in a Metal Insert (Ensats), install it vertically. Refer to the User's Manual for Metal Insert (Ensats) by the Maker.

Necessary items

● Special tool

● Spanner wrench

● Bolt, nut (When you use the bolt, nut)

Procedure

-Installation of Metal Insert (Ensats)

- 1) The expanding slot is done below, and Metal Insert (Ensats) is installed on a special tool.
- 2) It screws in up to prescribed straight depth in the hole in the under.
- 3) The nut is fixed with Spanner wrench.
- 4) The upper part of the tool is reversed and completion.

-When you use the bolt, nut

- 1) Metal Insert (Ensats) is made like a double nut and screws in.
- 2) The bolt side is fixed, it loosens a nut, and completion.

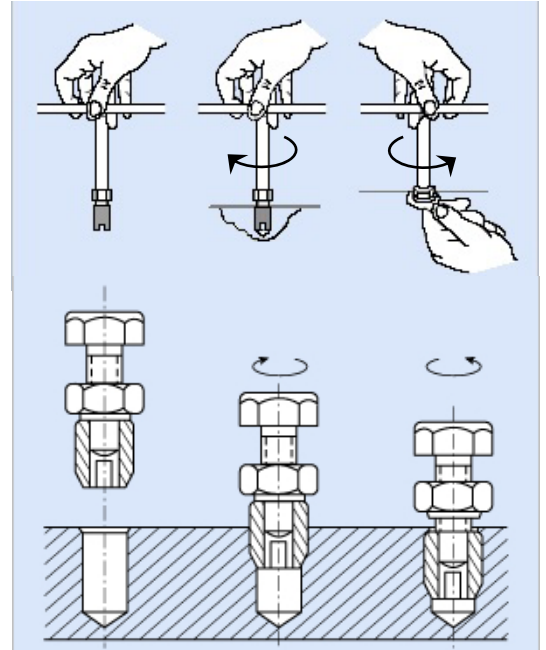

Bottom stand dimension

Unit ; mm (inch)

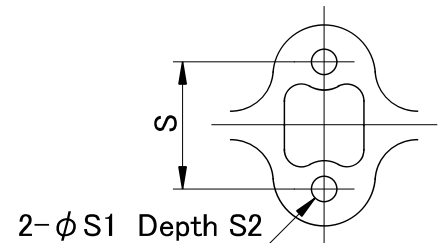

Nom. Size	S	S1	S2
15 - 32mm (1/2" - 1 1/4")	25 (0.98)	7 (0.28)	13 (0.51)
40, 50mm (1 1/2", 2")	45 (1.77)	9 (0.35)	15 (0.59)
65mm (2 1/2")	85 (3.35)	11 (0.43)	20 (0.79)
80mm (3")	100 (3.94)	15 (0.59)	28 (1.10)
100mm (4")	120 (4.72)	15 (0.59)	28 (1.10)

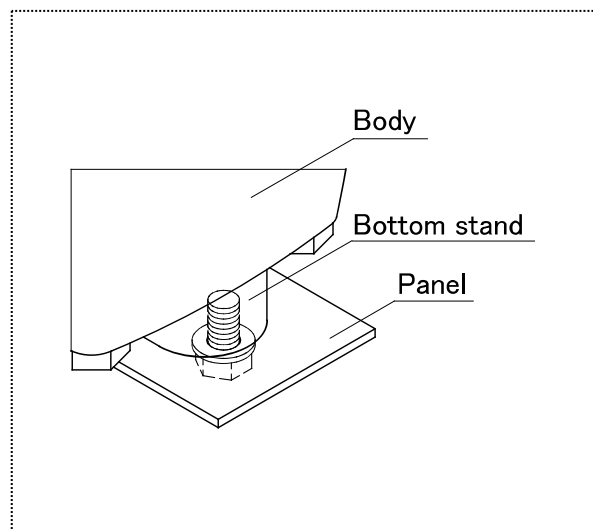
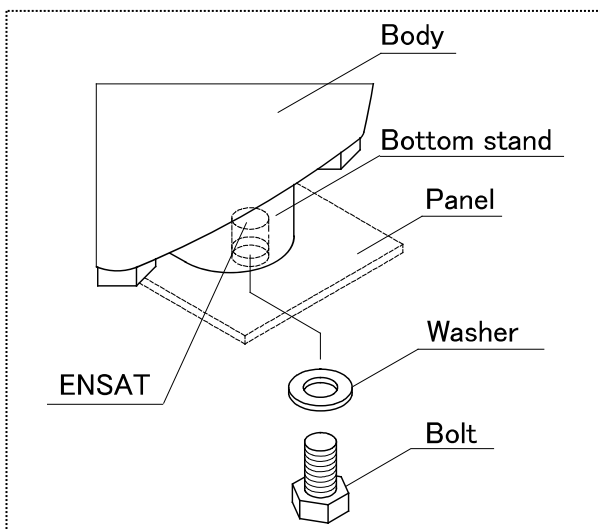

Fixation of bottom stand with panel



(14) Inspection items

  - Perform periodic maintenance. (Leakage may develop due to temperature changes or over periods of prolonged storage, rest or operation.)



○Inspect the following items.

(1)	Check for any flaw, crack, or deformation on the outside.
(2)	Check whether fluid leaks to the outside.
(3)	Check the tightness of coupled bolt nut between the body and the bonnet and that of the gauge cover (loose or not).
(4)	Check whether the handle can be operated smoothly.
(5)	Check whether the cap nut has been loosened. (only true union diaphragm valve.)

(15) Troubleshooting

Problem	Cause	Treatment
Fluid is leaking past the fully closed position.	The travel stop is not set correctly.	Adjust the travel stop.
	Solid particles have lodged in the valve.	Clear the solid particles from the valve.
	Media has worn diaphragm and / or weir.	Replace.
Valve can not be fully open.	The diaphragm has pulled off the stem.	Replace diaphragm. If the valve is in vacuum service, special vacuum valves may be required. Consult factory.
	The metal joint failed.	Remove Diaphragm & compressor and replace joint.
The handle spins freely.	The stem is broken.	Disassemble bonnet and replace the stem.
	The metal joint failed.	Remove diaphragm & compressor and replace joint.
Valve leaks between body and bonnet.	Bonnet bolts have loosened.	Re-tighten.
	Media has crystallized on the diaphragm.	Disassemble and clean on a regular basis. Replace failed diaphragm, if necessary.
	The diaphragm has failed due to fatigue.	Replace.
Valve leaks from stem.	The diaphragm has failed.	Replace.

(16) Handling of residual and waste materials

  - Make sure to consult a waste treatment dealer for recommendations on the proper disposal of plastic valves. (Poisonous gas is generated when the valve is burned improperly.)

**Diaphragm Valve Type14
True Union Diaphragm Valve Type14**

ASAHI YUKIZAI CORPORATION



Distributor

<http://www.asahi-yukizai.co.jp/en/>

Information in this manual is subject to change without notice.

July 2017